

# USER MANUAL

For E1/E2/G1/G2/M2/1U series encoders

Changsha KILOVIEW Electronics CO.,LTD.

## Legal Notices

*Subject to the receiving of this document from Changsha Kiloview Electronics Co., Ltd.,(Hereinafter referred to "Kiloview"), the following terms are understood and agreed. Or else, please stop using this document.*

*This document is copyright of Kiloview, all rights reserved. The document covers the proprietary information of the company. No company or individual may copy, transmit, distribute, use or disclose the document and any images, forms, data and other information contained in the document without the prior written permission of the company.*

 *is the registered trademark of Kiloview. The name and logo are the trademarks or registered trademarks of the company. Other products or company names mentioned in this document may be the trademarks or registered trademarks of their respective owners. The reading of this document without the prior written consent of the company or the third party rights holder does not imply that the reader is given any right to use any of the marks appearing in this document by implication, non-evidence or otherwise.*

*This product complies with the design requirements related to environmental protection and personal safety. The storage, usage and disposal of the product shall be in accordance with the product manual, relevant contract or relevant national laws and regulations.*

*This document is provided "as is" and "only in this state". Products and technical updates are subject to change without prior notice.*

*For matters not covered in this document, please visit our website [www.kiloview.com](http://www.kiloview.com) for information and technical support.*

# CONTENTS

<b>1 PRODUCT INTRODUCTION .....</b>	<b>1</b>
1.1 E SERIES WIRED VIDEO ENCODER .....	1
1.1.1 Advantages .....	1
1.1.2 Parameters .....	2
1.2 G SERIES WIRELESS VIDEO ENCODER .....	3
1.2.1 Advantages .....	3
1.2.2 Parameters .....	4
1.3 M2 WIRED VIDEO ENCODER .....	5
1.3.1 Advantages .....	5
1.3.2 Parameters .....	6
1.4 1U SERIES RACK-MOUNTED VIDEO ENCODER.....	7
1.4.1 Advantages .....	7
1.4.2 Parameters .....	8
<b>2 OPERATION GUIDANCE .....</b>	<b>9</b>
<b>3 PACKING LIST AND INTERFACE DESCRIPTION .....</b>	<b>10</b>
3.1 PACKING LIST.....	10
3.2 DEVICE INTERFACES .....	10
3.3 LED INDICATOR DESCRIPTIONS.....	13
<b>4 INSTALLATION AND CONNECTION .....</b>	<b>13</b>
4.1 E/G SERIES INSTALLATION AND CONNECTION .....	13
4.1.1 Connect the power adapter .....	13
4.1.2 Connecting video signal.....	14
4.1.3 Connect network.....	14
4.1.4 Connect WIFI antenna (for wireless encoder only) .....	14
4.2 M2 INSTALLATION AND CONNECTION .....	14
4.2.1 Connect the power adapter .....	14
4.2.2 Connecting video signal.....	15
4.2.3 Connect network.....	15
4.3 1U SERIES INSTALLATION AND CONNECTION.....	15
4.3.1 Connect the power adapter .....	15
4.3.2 Connecting video signal.....	16
4.3.3 Connect network.....	16
<b>5 LOGIN AND NETWORK CONFIGURATION .....</b>	<b>17</b>
5.1 LOGIN TO THE DEVICE THROUGH ETHERNET .....	17
5.2 LOG IN TO THE DEVICE THROUGH THE WIFI HOTSPOT ( ONLY G SERIES WIRELESS ENCODERS ) .....	18
5.3 NETWORK CONFIGURATION.....	18
5.3.1 Ethernet .....	18
5.3.2 WIFI network (Only G series wireless encoders) .....	19
5.3.3 4G Network (Only for G series encoders).....	22
5.3.4 Convenient management functions.....	23

5.3.5 Android APP .....	24
<b>6 PARAMETERS CONFIGURATION .....</b>	<b>2</b>
6.1 DASHBOARD .....	2
6.2 BASIC SETTINGS .....	3
6.2.1 Change WEB login password .....	3
6.2.2 Location and time .....	4
6.2.3 Restore factory settings .....	5
6.2.4 Firmware upgrading .....	5
6.3 VIDEO & AUDIO ADJUSTMENTS.....	6
6.3.1 Video source choice and adjustments.....	6
6.3.2 Video preprocessing.....	6
6.3.3 Audio signal source .....	8
6.4 ENCODING & STEAM .....	8
6.4.1 Audio encoding parameter setting .....	8
6.4.2 Encoding and stream settings.....	9
6.4.3 Streaming media service.....	11
6.4.3.1 Motion JPEG stream .....	11
6.4.3.2 RTSP service.....	11
6.4.3.3 RTMP Pushing (Live streaming) .....	13
6.4.3.4 TS-UDP Pushing (unicast and multicast) .....	15
6.4.3.5 HLS service.....	17
6.4.3.6 SRT-TS pushing.....	18
6.5 LOCAL RECORDING .....	20
6.6 NETWORK STORAGE (NAS) .....	23
6.7 TEXT/ IMAGE/TIME OVERLAY.....	24
6.7.1 Overlay Image Management.....	25
6.7.2 Overlay function .....	25
6.8 SERVICE CONFIGURATION .....	28
6.8.1 Web Service Configuration .....	28
6.8.2 Onvif Service Configuration .....	28
6.8.3 Telnet Service Configuration .....	29
6.9 SERIAL PORTS AND PTZ.....	29
6.9.1 Serial Ports.....	29
6.9.2 PTZ Setting.....	30
6.9.3 Control Panel .....	30
6.10 QUICK RESET AND REBOOT .....	30
6.10.1 Quick Reset .....	30
6.10.2 Reboot .....	31
6.11 LOGS AND DEBUG .....	31
6.12 PRESET CONFIGURATION .....	32

## 1 Product introduction

### 1.1 E series wired video encoder

E series video encoder can encode SDI or HDMI video source and compress into IP stream, to realize long-distance HD transmission/live broadcast over WAN or LAN network.



#### 1.1.1 Advantages

- **High bandwidth adaptability, makes it possible to transmit high definition, low-latency, non-padding image under low bit network.**
  - With branded chips solution together with video dynamic noise reduction and image enhancement technology, it can realize good encoding image under low bit transmission;
  - Good video image can be achieved at 1Mbps@720p, 1.5Mbps@1080p network;
  - Advanced video buffering technology and FEC technology ensures video encoding delay  $\leq 67\text{ms}$  and stable and smooth transmission;
  - Adjustable bit rate from 64kbit/s ~ 40Mbit/s.
- **Powerful streaming media service function, supports RTSP/RTMP/UDP-TS/Onvif/SIP/SRT and some other protocols.**
  - SRT/ RTSP/ RTMP/ HLS/ UDP-TS/ Onvif and some other streaming media protocols supported for live broadcast on Facebook, YouTube, Ustream, Twitch, Wowza etc or security platform /NVR system;
  - Dual stream output, the main code rate up to 1080p60Hz, and the sub-stream supports 720p60Hz video encoding.

- **Portable and low power consumption makes it 24 hours continuous working available.**
- Capable with customized text and image overlay function, which can be at any position on the screen;
- Audio embedding encoding supported, with voice intercom function (need to deploy voice intercom software);
- Supports NAS network storage;
- With video real-time loop function, there is no delay and convenient for live monitoring;
- 24h continuous working available.

**Note: ( $\leq 67\text{ms}$ ) refers to the delay of the encoder end, and the end-to-end delay also relates to network, decoding, etc.**

### 1.1.2 Parameters

Model	E1 (SDI), E2 (HDMI)
Video input	1*BNC SDI (E1); 1*HDMI (E2)
Video Loop out	1*BNC SDI (E1); 1*HDMI (E2)
Analog audio input	2*3.5mm
USB interface	2*USB 2.0 Type-A; 1*USB 2.0 Mini-USB
Network Support	RJ-45 Ethernet
Media transmission protocols	RTMP/HLS/TS over UDP/RTSP /Onvif/SRT
Video resolution	Up to 1080P60Hz, resolutions supported: E1: 1080p23.98/24/25/29.97/30Hz, 1080p50/59.94/60Hz, 1080i50/59.94/60Hz, 720p23.98/24/25/29.97/30Hz, 720p50/59.94/60Hz E2: 1080p23.98/24/25/29.97/30Hz, 1080p50/59.94/60Hz, 1080i50/59.94/60Hz, 720p30/50/59.94/60Hz.
Video coding	H264/AVC, Motion-JPEG
Audio coding	AAC/G.711
Encoding latency	$\leq 67\text{ms}$
Image and text overlay	Custom text, image overlay function, can be superimposed to any position on the screen
Recording	Micro SD/TF card , local recording, NAS network storage
Management	WEB/Android APP
Power supply/consumption	DC 12V 1A / 4W
Operating temperature	125*89*28mm / 380g
Size/Weight	-20°C~55°C

## 1.2 G series wireless video encoder

G series video encoder can encode SDI or HDMI video source and compress into IP stream, to realize long-distance HD transmission/live broadcast over WAN or LAN network.



### 1.2.1 Advantages

- **Built-in WIFI module, wireless video transmission/live broadcast supported.**
  - Built-in dual-band (2.4G/5.0GHz) WIFI module, it supports wireless transmission/ live broadcast of mobile video sources in local space;
  - Built-in self-adaptive Ethernet interface, wired network transmission is also supported;
  - Low power consumption, 24 hours continuous working available.
- **Powerful streaming media service function, supports RTSP/RTMP/TS/Onvif/SIP/SRT and some other protocols.**
  - Dual stream output, the main code rate up to 1080p60Hz, and the sub-stream supports 720p 60Hz video encoding.
  - Capable with customized text and image overlay function, which can be at any position on the screen;
  - Audio embedding encoding supported, with voice intercom function (need to deploy voice intercom software);
  - Supports NAS network storage;
  - With video real-time loop function, there is no delay and convenient for live monitoring.

- **High bandwidth adaptability makes it possible to transmit high-definition, low-latency, non-padding image under low bit network.**
- With branded chips solution together with video dynamic noise reduction and image enhancement technology, it can realize good encoding image under low bit transmission;
- Good video image can be achieved at 1Mbps@720p, 1.5Mbps@1080p network;
- Advanced video buffering technology and FEC technology ensures video encoding delay  $\leq 67\text{ms}$  and stable transmission;
- Adjustable bit rate from 64kbit/s ~ 40Mbit/s.

**Note: ( $\leq 67\text{ms}$ ) refers to the delay of the encoder end, and the end-to-end delay also relates to network, decoding, etc.**

### 1.2.2 Parameters

Model No.	G1, G2
Input	1*BNC SDI (G1); 1*HDMI (G2)
Video Loop out	1*BNC SDI (G1); 1*HDMI (G2)
Analog audio input	2*3.5mm
USB interface	2*USB 2.0 Type-A
Network Support	Enhanced WIFI (Enhance 5.0GHz frequency), RJ-45 Ethernet
Media transmission protocols	RTMP/HLS/TS over UDP/RTSP /Onvif/SRT
Video resolution	Up to 1080P60Hz, resolutions supported: G1: 1080p23.98/24/25/29.97/30Hz, 1080p50/59.94/60Hz, 1080i50/59.94/60Hz, 720p23.98/24/25/29.97/30Hz, 720p50/59.94/60Hz G2: 1080p23.98/24/25/29.97/30Hz, 1080p50/59.94/60Hz, 1080i50/59.94/60Hz, 720p30/50/59.94/60Hz.
Video coding	H264/AVC, Motion-JPEG
Audio coding	AAC/G.711
Encoding latency	$\leq 67\text{ms}$
Image and text overlay	Custom text, image overlay function, can be superimposed to any position on the screen
Recording	Micro SD/TF card , local recording, NAS network storage
Management	WEB/Android APP
Power supply/consumption	DC 12V 1A / 4W
Size/Weight	125*89*28mm / 380g
Operating temperature	-20°C~55°C



### 1.3 M2 wired video encoder

M2 video encoder can encode VGA/HDM video source and compress into IP stream, to realize long-distance HD transmission/live broadcast over WAN or LAN network.



#### 1.3.1 Advantages

- **Dual interface design, compatible with various VGA video sources or HDMI video sources.**
  - VGA interface compatible with VGA/ XGA/ UVGA/ SVGA/ SXGA/SXGA+/ WXGA/ WXGA+/ WSXGA/ WUXGA and other video sources;
  - HDMI interface compatible with HDMI1.4 and below;
  - 24h continuous working available.
  
- **Powerful streaming media service function, supports RTSP/RTMP/TS/Onvif/SIP/SRT and some other protocols**
  - SRT/ RTSP/ RTMP/ HLS/ TS/ Onvif and some other streaming media protocols supported for live broadcast on Facebook, YouTube, Ustream, Twitch, Wowza etc or security platform /NVR system;
  - Dual stream output, the main code rate up to 1080p60Hz, and the sub-stream supports 720p 60Hz video encoding.
  - Capable with customized text and image overlay function, which can be at any position on the screen;
  - Supports NAS network storage.

- **High bandwidth adaptability makes it possible to transmit high-definition, low-latency, non-padding image under low bit network.**
- With branded chips solution together with video dynamic noise reduction and image enhancement technology, it can realize good encoding image under low bit transmission;
- Good video image can be achieved at 1Mbps@720p, 1.5Mbps@1080p network;
- Advanced video buffering technology and FEC technology ensures video encoding delay  $\leq 67$ ms and stable transmission;
- Adjustable bit rate from 64kbit/s ~ 40Mbit/s.

**Note: ( $\leq 67$ ms) refers to the delay of the encoder end, and the end-to-end delay also relates to network, decoding, etc.**

### 1.3.2 Parameters

Model No.	M2
Input	1*VGA+1*HDMI
Analog audio input	2*3.5mm
USB interface	2*USB 2.0 Type-A
Network Support	RJ-45 Ethernet
Media transmission protocols	RTMP/HLS/TS over UDP/RTSP /Onvif/SRT
Video resolution	Up to 1080P60Hz, details as below: 1080p/1080i/720p/480p/576p/480i/576i(up to 60Hz) Compatible with VESA display resolution, up to 1920*1200@60Hz
Video coding	H264/AVC, Motion-JPEG
Audio coding	AAC/G.711
Encoding latency	$\leq 67$ ms
Image and text overlay	Custom text, image overlay function, can be superimposed to any position on the screen
Recording	local recording, NAS network storage
Management	WEB/Android APP
Power supply/consumption	DC 12V 1A / 4W
Operating temperature	125*89*28mm / 380g
Size/Weight	-20°C~55°C

## 1.4 1U series rack-mounted video encoder

The rack-mounted encoder refers to an integrated single, quad or multi-channel SDI/HDMI video encoding module in a 1U/3U rack-mount frame through plug-in card. Through wired network to realize remote video transmission / live broadcast.



### 1.4.1 Advantages

- **Highly integrated, low power consumption, stable operation**
  - It can integrate 1U single-channel, 1U four-channels, or 3U multi-channels SDI/ HDMI video encoding module, and supports up to 32-channels in 3U rack. SDI encoding module and HDMI encoding module can be integrated into the same rack for customization;
  - Advanced low-power consumption design (150w only for 32 channels at full load), together with built-in intelligent cooling device, it can ensure stable operation, makes 24h continuous working available.
- **High bandwidth adaptability, it can transmit high-definition, low-latency image without padding even under a low-bandwidth network environment**
  - With branded chips solution together with video dynamic noise reduction and image enhancement technology, it can realize good encoding image under low bit transmission;
  - Good video image can be achieved at 1Mbps@720p, 1.5Mbps@1080p network. In the normal scene, 1Mbps@720p, 1.5Mbps@1080p can get high quality video quality;
  - Advanced video buffering technology and FEC technology ensures video encoding delay  $\leq 67$ ms and transmission stable without non-padding.
  - Adjustable bit rate from 64kbit/s ~ 40Mbit/s.

**Note:** ( $\leq 67$ ms) refers to the delay of the encoder end, and the end-to-end delay also relates to network, decoding, etc.

- **Powerful streaming media service function, all types of streaming media protocol supported**
- SRT/ RTSP/ RTMP/ HLS/ TS/ Onvif and some other streaming media protocols supported for live broadcast on Facebook, YouTube, Ustream, Twitch, Wowza etc or security platform /NVR system;
- Dual stream output, the main code rate up to 1080p60Hz, and the sub-stream supports 720p 60Hz video encoding.

#### 1.4.2 Parameters

Model	U1-1; U2-1; U1-4; U2-4
Video interface	U1-1: 1*BNC SDI; U2-1: 1*HDMI; U1-4: 4*BNC SDI; U2-4: 4*HDMI
Video loop	U1-1: 1*BNC SDI; U2-1: 1*HDMI; U1-4: 4*BNC SDI; U2-4: 4*HDMI
Network Support	Wired Ethernet
Media transmission protocols	RTMP/HLS/TS over UDP/RTSP /Onvif/SRT
Video resolution	Supports up to 1080P60Hz resolution
Video coding	H264/AVC, Motion-JPEG
Audio coding	AAC/G.711
Encoding latency	≤67ms
Image and text overlay	Custom text, image overlay function, can be superimposed to any position on the screen
Recording	NAS network storage
Management	WEB
Power supply/consumption	AC 220v 25W/U series: up to 25W
Operating temperature	483*175.25*44.5mm/1.6kg
Size/Weight	-20℃~55℃

## 2 Operation guidance

- Installation and connection of the device

Connect the power and video input source correctly, power on the device.

- Network Connection and Configuration

If you want to set up the network manually, when using wired connection mode, you can use the device failsafe IP address (192.168.1.168) to login the WEB page for setting up; At the same time, for convenience of operation, you can also connect the device's own WIFI hotspot to configure device through other WIFI terminal, such as mobile phone or pad. If you use the wireless network push flow, you must first log on to the device web Page to set up WIFI.

- RTSP pull flow

The decoder's RTSP stream is directly pulled using a decoder or a PC-side player (such as VLC), and the RTSP stream service is continuously turned on.

- Other streaming service

If necessary, you can also configure the device to push video streams such as RTMP, RTMPS, UDP, HLS, etc.

### 3 Packing list and interface description

#### 3.1 Packing list

E/G/M Series packing list			
Name	Unit	Quantity	Note
Encoder	PCS	1	E1&G1:SDI Input E2&G2:HDMI Input M2:HDMI&VGA Input
WIFI Antenna	PCS	2	Only for G series wireless encoders
DC12V/1A power adaptor	PCS	1	
Quick start guide	PCS	1	
Certificate/Warranty card	PCS	1	

1U rack packing list			
Name	Unit	Quantity	Note
Encoder	PCS	1	U1:SDI Input; U2:HDMI Input
AC 220v Power cable	PCS	1	
Quick start guide	PCS	1	
Certificate/Warranty card	PCS	1	

#### 3.2 Device interfaces

##### E/G Series device interfaces



1, Power input

2, Mini-USB

3, Audio output

4, Audio Line in

5,SDI IN/HDMI LOOP

6,SDI LOOP/HDMI IN

7,100M Ethernet interface

8,Status leds



- 9, USB interface
- 10, Micro SD/TF Card
- 11, Power Switch
- 12, Reset
- 13, WIFI Antenna (for wireless encoder only)

**M2 device interfaces**



- 1, Dial switch (for custom development only)
- 2, Reset
- 3, Power input



- 4, Audio output
- 5, Audio line in
- 6, RS-485 Interface
- 7, VGA IN
- 8, HDMI IN
- 9, 100M Ethernet interface
- 10, USB interface

**1U Single/multiple device interfaces**



- 1, Mini USB                      2, Audio output                      3, Audio line in                      4, HDMI LOOP/SDI IN
- 5, SDI LOOP/HDMI IN              6, 100M Ethernet interface      7, Status leds
- 8, Reset                              9, AC 220V Power input              10, Power Switch





- 1, Mini USB                      2, Audio output                      3, Audio line in                      4, HDMI LOOP/SDI IN
- 5, SDI LOOP/HDMI IN              6,100M Ethernet interface 7, Status leds
- 8, Reset                              9, AC 220V Power input              10, Power Switch



### 3.3 LED indicator descriptions

#### E/G/M/1U LED indicator status

Name	Color	Status	Description
POWER 	Red	Always on	Power supply is connected
		Flashing	Power failure
		Off	Power supply is not connected
SIGNAL 	Green	Always on	SDI/HDMI signal is connected
		Flashing	Restore device to factory settings
		Off	SDI/HDMI signal is not connected
RUN 	Green	Always on	Device is starting
		Flashing	Restore device to factory settings
		Off	Working abnormal/not started

## 4 Installation and Connection

### 4.1 E/G series installation and connection

#### 4.1.1 Connect the power adapter

Using the power adapter (DC 12v) connect to the main product, after the power is turned on, then the product starts working immediately.



**⚠️ Note:** Please use the standard power adapter provided. Using other unqualified power supplies may damage the device.

### 4.1.2 Connecting video signal

Connect the SDI/HDMI signal from the source (such as a camera) to the SDI/HDMI input port of the device via a cable.



**Note: HDMI and SDI device interface input and loop position is different. It is subject to the actual device.**

### 4.1.3 Connect network

Connect one end of the network cable to the encoder Ethernet port. The other end is connected to the network switch or the computer's Ethernet port.

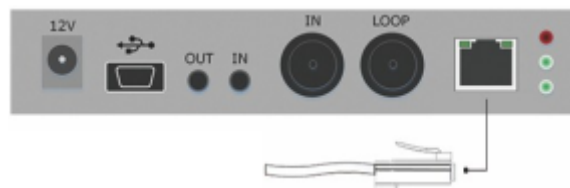

### 4.1.4 Connect WIFI antenna (for wireless encoder only)

Connect the WIFI antenna with the device antenna interface.

## 4.2 M2 installation and connection

### 4.2.1 Connect the power adapter

Conncting the power adapter (DC 12v) to the main product, then the product starts working immediately.



 **Note: Please use the standard power adapter provided. Using other unqualified power supplies may damage the device.**

### 4.2.2 Connecting video signal

Connect the VGA/HDMI signal from the source (such as a camera) to the SDI/HDMI input port of the device via a cable.

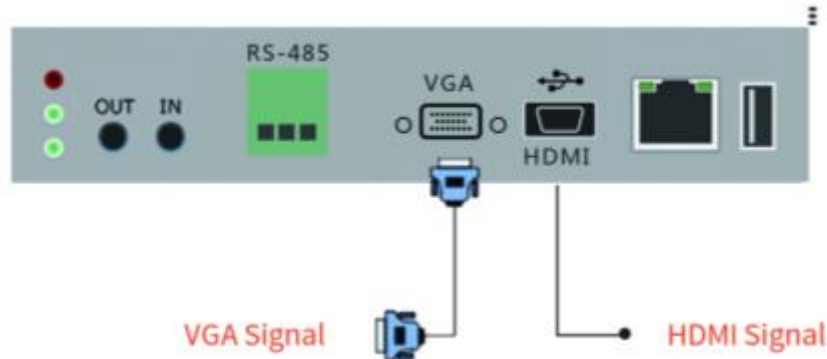

### 4.2.3 Connect network

Connect one end of the network cable to the encoder Ethernet port. The other end is connected to the network switch or the computer's Ethernet port.



## 4.3 1U series installation and connection

### 4.3.1 Connect the power adapter

Using the power adapter (AC 220V) connect to the main product, after the power is turned on, then the product starts working immediately.



**⚠️ Note:** Please use the standard power adapter provided. Using other unqualified power supplies may damage the device.

### 4.3.2 Connecting video signal

Connect the SDI/HDMI signal from the source (such as a camera) to the SDI/HDMI input port of the device via a cable.

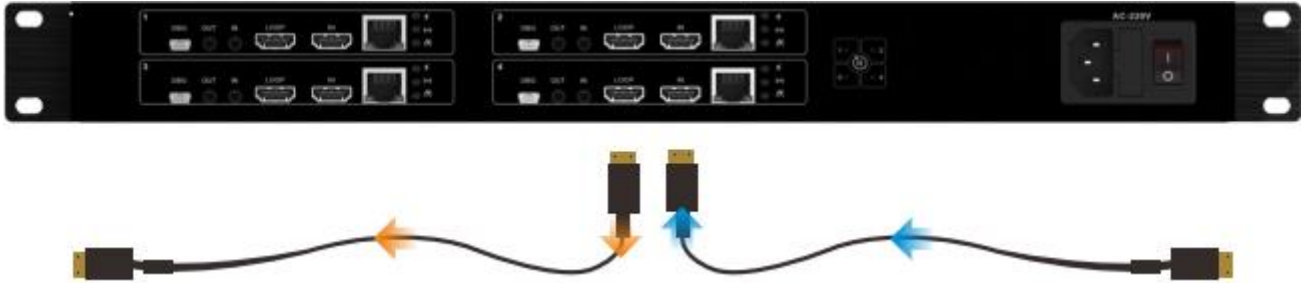

**Note: HDMI and SDI device interface input and loop position is different. It is subject to the actual device.**

### 4.3.3 Connect network

Connect one end of the network cable to the encoder Ethernet port. The other end is connected to the network switch or the computer's Ethernet port.



## 5 Login and network configuration

### 5.1 Login to the device through Ethernet

First connect the RJ45 Ethernet port of the encoder and the computer to the same switch, or connect the encoder directly to the computer network port. Then configure the encoder and computer to the same network segment so that the computer can access to the web page of the encoder.

The default management IP address of the encoder is 192.168.1.168 (This is the failsafe address of the device. Generally, do not modify this IP address.) . If the IP address of the computer is not in the network segment of 192.168.1.\* , please set the IP address of the computer network port to 192.168.1.\*.

Open the WEB browser, directly input the encoder's IP address (default is 192.168.1.168) or the URL <http://192.168.1.168> and press Enter to open the login interface. After opening the page, an authentication dialog will pop up, please fill in the username and password, the default username is admin, the default password is admin, and then click "Login".

 **Note:** Due to the browser compatibility issues, it may cause the web page display abnormal, it is recommended to use Chrome and Firefox.

After login, the encoding and function parameters can be set on the encoder management web page. The page is shown as below:

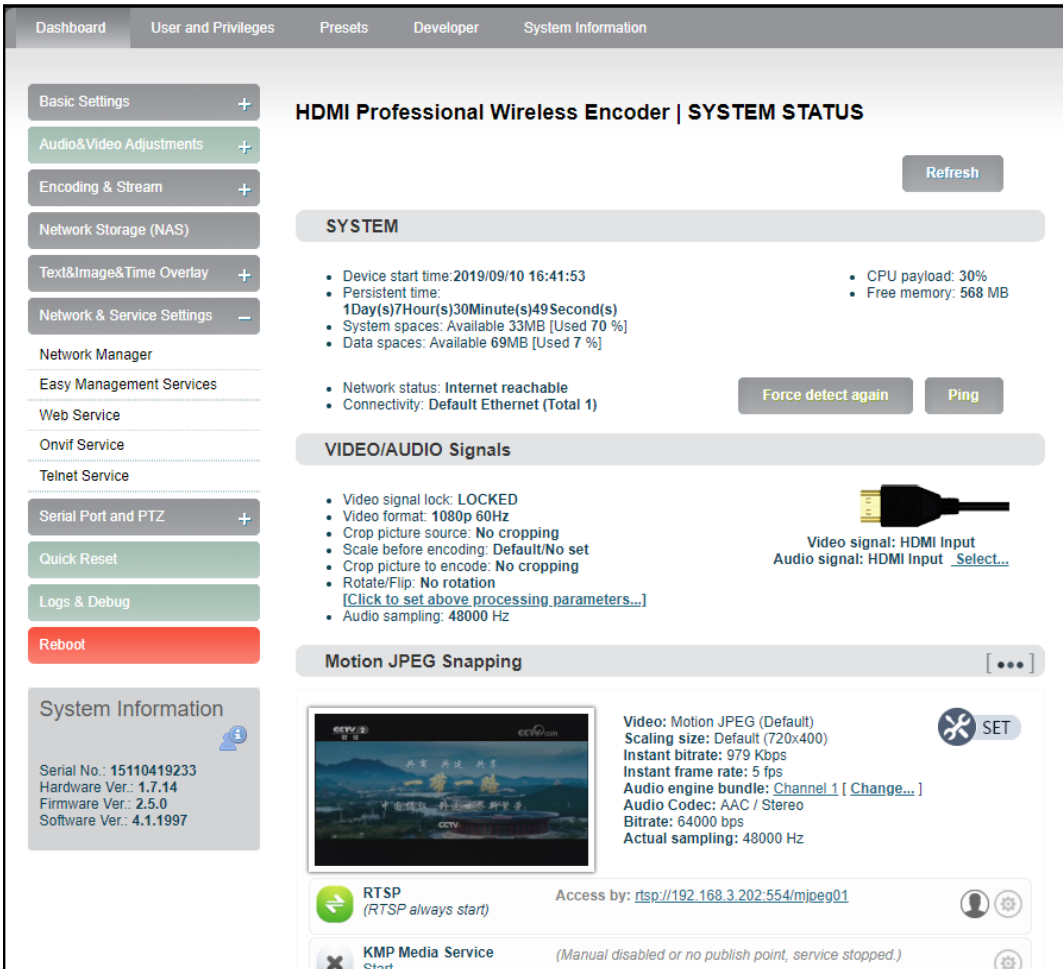

The screenshot displays the web management interface for an HDMI Professional Wireless Encoder. The main content area is titled "SYSTEM STATUS" and includes several sections:

- SYSTEM:**
  - Device start time: 2019/09/10 16:41:53
  - Persistent time: 1Day(s)7Hour(s)30Minute(s)49Second(s)
  - System spaces: Available 33MB [Used 70 %]
  - Data spaces: Available 69MB [Used 7 %]
  - CPU payload: 30%
  - Free memory: 568 MB
- Network:**
  - Network status: Internet reachable
  - Connectivity: Default Ethernet (Total 1)
- VIDEO/AUDIO Signals:**
  - Video signal lock: LOCKED
  - Video format: 1080p 60Hz
  - Crop picture source: No cropping
  - Scale before encoding: Default/No set
  - Crop picture to encode: No cropping
  - Rotate/Flip: No rotation
  - Audio sampling: 48000 Hz
- Motion JPEG Snapping:**
  - Video: Motion JPEG (Default)
  - Scaling size: Default (720x400)
  - Instant bitrate: 979 Kbps
  - Instant frame rate: 5 fps
  - Audio engine bundle: Channel 1 [Change...]
  - Audio Codec: AAC / Stereo
  - Bitrate: 64000 bps
  - Actual sampling: 48000 Hz

On the left side, there is a navigation menu with options like Basic Settings, Audio&Video Adjustments, Encoding & Stream, Network Storage (NAS), Text&Image&Time Overlay, Network & Service Settings, Network Manager, Easy Management Services, Web Service, Onvif Service, Telnet Service, Serial Port and PTZ, Quick Reset, Logs & Debug, and Reboot. At the bottom left, a System Information box shows: Serial No.: 15110419233, Hardware Ver.: 1.7.14, Firmware Ver.: 2.5.0, Software Ver.: 4.1.1997.

## 5.2 Log in to the device through the WIFI hotspot (Only G series wireless encoders)

In order to facilitate user management, the user can also connect to the device through WIFI terminal. The device comes with a WIFI hotspot by default. Hotspot name is "CAST\_AP" and the hotspot password is "12345678". You can use a WIFI terminal such as a mobile phone or laptop to connect to this hotspot to log in and manage the encoder device. After connecting to this hotspot, you can log in to the management interface of the encoder by entering `http://192.168.250.254` in the browser of your mobile phone or laptop.

 **Note: The WIFI hotspot function is recommended only for starting use and for convenient log in to the device. In the process of streaming with WIFI, Please do not to use the hotspot function to avoid affecting the streaming.**

## 5.3 Network configuration

The The encoder supports Ethernet,WiFi and 4G. The specific configuration of the network is described in detail below.

### 5.3.1 Ethernet

The encoder can provide an Ethernet access through. This port can be configured with an IP address and default setting is DHCP. It will automatically get a complete IP address, gateway and DNS according to this LAN.

Click "Network & Service Settings", click "Network Manager" to enter the following interface, you can see the IP address with Ethernet.

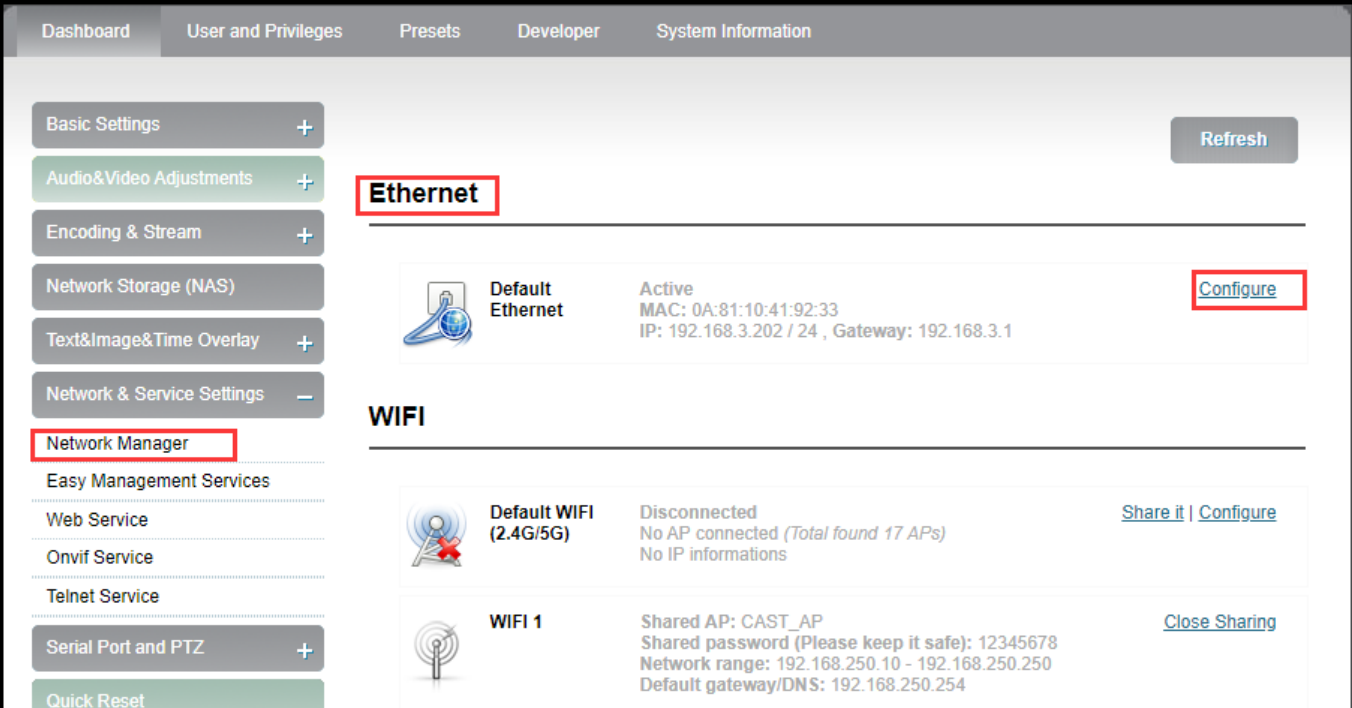

The screenshot shows the 'Network Manager' interface. On the left sidebar, 'Network Manager' is highlighted with a red box. The main content area is divided into two sections: 'Ethernet' and 'WIFI'. The 'Ethernet' section shows 'Default Ethernet' is 'Active' with a 'Configure' button highlighted in red. The 'WIFI' section shows 'Default WIFI (2.4G/5G)' is 'Disconnected' and 'WIFI 1' is 'Shared AP: CAST\_AP' with a 'Close Sharing' button.

In addition to the way of DHCP, the encoder also supports manual IP assignment. To change the IP of the wired network, click “Configure” button in the Ethernet to enter the interface for configuring the IP. There are two ways to get the address, one is DHCP, and the other is to manual. To use DHCP to automatically obtain IP, you must first ensure that the router or switch has enabled the DHCP service. This method is simple and convenient, but the IP obtained by DHCP changes continuously, and you cannot directly know what IP address the encoder gets. To use manual, you need to enter a fixed IP to the encoder, and this IP address is fixed as long as the encoder does not restore the factory settings, this method is more stable. Therefore, the two methods have their own advantages, and can be selected accordingly.

### LAN Connection

---

MAC:

MAC Clone:

Address Resolve:

IP Address:

Net Mask:

Gateway:

DNS1:

DNS2:



After Ethernet is configured correctly, you can see that the connection status is “Internet reachable” and the Internet connection is the default Ethernet port on the Information Board.

### 5.3.2 WIFI network (Only G series wireless encoders)

WIFI configuration has two modes, which can realize two functions. "Default WIFI" is used as ordinary terminal, connect router WIFI signal, use WIFI to transmit video; "WIFI1" is as AP hot spot to be connected by other devices, default hot spot name is "CAST\_AP" and the hot spot password is "12345678". You can use a mobile phone or laptop to connect to this hot spot to log in and manage the encoder. After connecting to this hot spot, you can log in to the encoder's web page by typing "192.168.250.254" in the browser of your mobile phone or laptop. As shown in the figure below, click “Set as Shared Hot spot” of WIFI 1 to customize the shared hot spot name and shared password. You can select the WIFI channel and the network card to be shared.

**Share it**
✕

---

Sharing AP name:

Disable broadcast SSID:

Sharing key:

Select a Wifi channel:

Through this device to Internet:

For normal use, just click "Default WIFI" option to enter the interface that connects to WIFI. Click "WIFI scanning list" to connect, usually you need to enter a WIFI password to connect successfully. For some WIFI that hides the SSID, you can also connect a hidden hot spot by manual. The WIFI that has been successfully connected, the encoder will save this record. By default, this WIFI will be automatically connected next time. You can also select this saved WIFI hot spot to disconnect or delete the WIFI.

### Advanced WIFI Settings

---

Country/Domain/Standard:

WIFI Roaming:

### Default WIFI Saved connections

---

(No saved connection)

### WIFI scanning list

---

<div style="display: flex; align-items: center;"> <span>Kiloview03</span> </div>	<div style="display: flex; align-items: center;"> <span>CAST_AP</span> </div>
<div style="display: flex; align-items: center;"> <span>NEWTEK-CONNECT</span> </div>	<div style="display: flex; align-items: center;"> <span>Kiloview02</span> </div>

**⚠️ Note:** In order to reduce the wireless network interference and obtain a good video playback experience, it is recommended to place the WIFI router and encoder in the visible range and connect the encoder to the 5.0GHz of the WIFI, and set the router to a relatively clean channel. In order to make sure the fluidity of the video while streaming with WIFI, the coding rate can be appropriately reduced as necessary.



---

When connecting to WIFI, there are two ways to obtain an IP address, DHCP and manual. Same as Ethernet, if using DHCP, be sure that the wireless router has enabled the DHCP service (usually turned on). This method is simple and convenient, but the IP obtained by DHCP changes continuously, and you cannot directly know what IP address the encoder gets and network cable connection is required for management. To use manual, you need to enter a fixed IP to the encoder, and this IP address is fixed as long as the encoder does not restore the factory settings, this method is more stable.



**Note:** When using WIFI function, it is better not to connect to the Ethernet at the same time, because Ethernet has higher priority than WIFI. If you use WIFI for streaming while need to connect to the Ethernet configuration, you must delete the gateway of Ethernet, make sure only one IP address of Ethernet is used to manage the encoder. If not, it may cause that WIFI streaming is not actually used even WIFI is connected.

---

### 5.3.3 4G Network (Only for G series encoders)

When a USB 4G network card is plugged into the encoder, an "Ethernet Port 1" is added to the "Wired Network" connection. After the USB card connected successfully, parameters such as the IP address are obtained from the 4G gateway and displayed as "Connected".

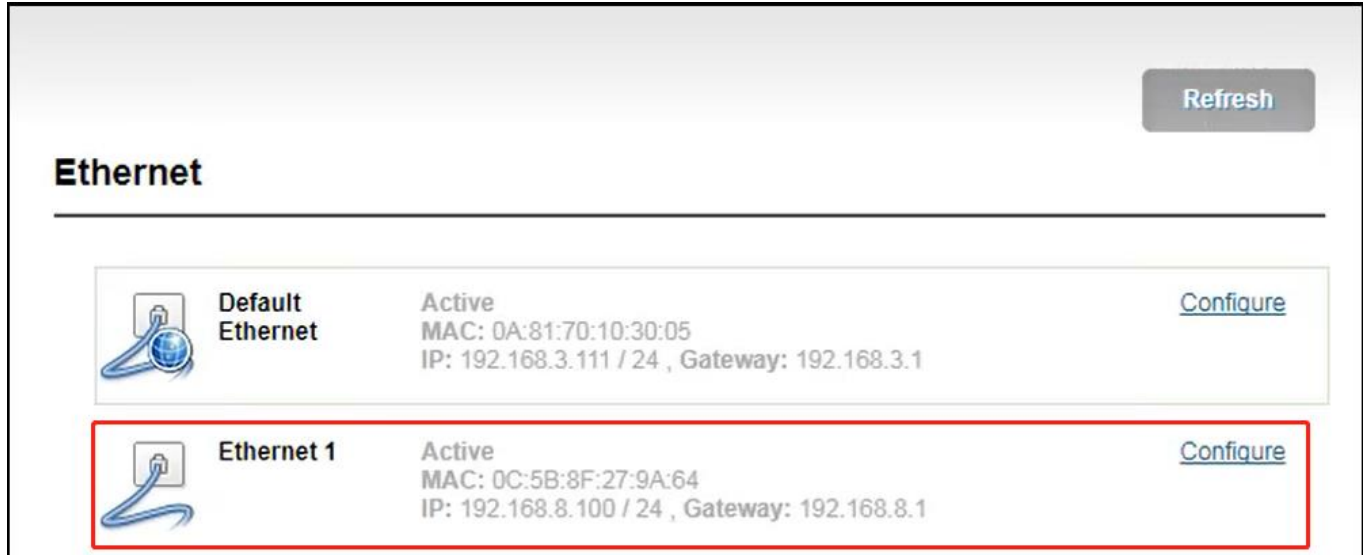

Network Name	Status	MAC Address	IP Address / Gateway	Action
Default Ethernet	Active	0A:81:70:10:30:05	192.168.3.111 / 24 , Gateway: 192.168.3.1	<a href="#">Configure</a>
Ethernet 1	Active	0C:5B:8F:27:9A:64	192.168.8.100 / 24 , Gateway: 192.168.8.1	<a href="#">Configure</a>

If USB 4G card is workable, "Dashboard" page will show "Network status" as "Internet reachable". "Connectivity" is "Ethernet Port 1" (If adopts Ethernet connection, it is showed as "Default Ethernet").

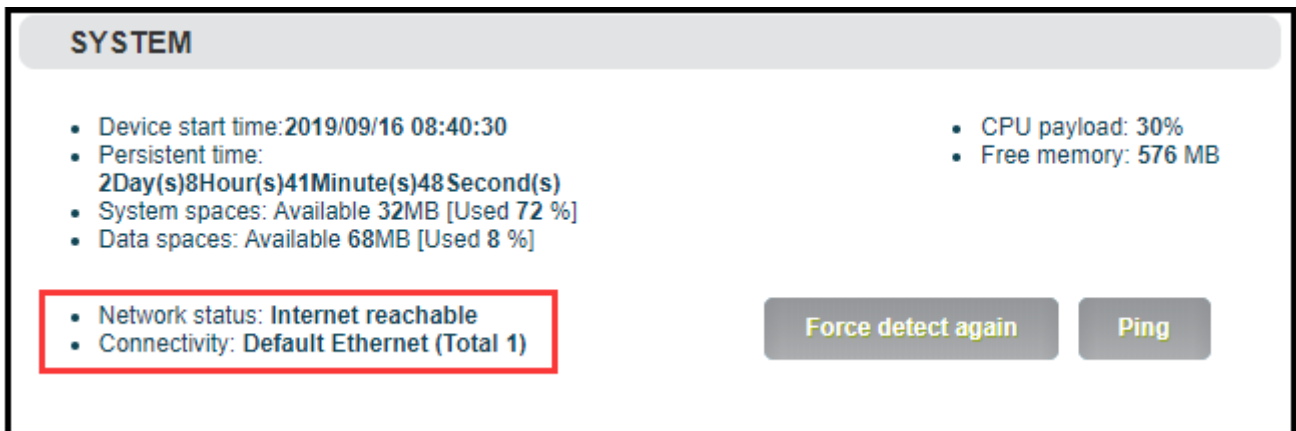

**SYSTEM**

- Device start time: 2019/09/16 08:40:30
- Persistent time: 2Day(s)8Hour(s)41Minute(s)48Second(s)
- System spaces: Available 32MB [Used 72 %]
- Data spaces: Available 68MB [Used 8 %]
- CPU payload: 30%
- Free memory: 576 MB

• Network status: Internet reachable  
 • Connectivity: Default Ethernet (Total 1)
 

[Force detect again](#)
[Ping](#)

**⚠️ Note:** Please confirm whether USB 4G card enables dial-up connection function, SIM card is workable, otherwise the network maybe unavailable. Users can insert a USB 4G card into a computer to test whether it can provide Ethernet access function.

### 5.3.4 Convenient management functions

The "localized connection" is configured with a dedicated IP address on Ethernet (This is the failsafe IP address of the Ethernet port. Generally, do not modify this IP address.) . In this way, even if you forget the IP settings of the Ethernet, or if the IP cannot be learned because DHCP gets the address, you can still connect and access the device through the configured private IP address.

#### Easy Management Service

---

**About Easy Management**

The 'Easy Management' service provide a easy way for users to manage/use this device. Two important functions is served: 1st, 'Local Link' on ethernet; 2nd, connect your Android or iOS phone/pad to this device.

'Local Link' function give a way to set a special static IP address on Ethernet port. Thus, even you forget the IP or unknow the dynamic IP, you can also access this device by that 'special static IP'.

This device enable you connect Android or iOS phone/pad to it, that you can manage it and watch live video by an App, and share your phone's 4G network.

**Local Link**

Enable Local Link:

Special IP Address:

Netmask:

Localized connection" is to bind the encoder to a separate IP address, this IP address does not affect the use of other network cards, in special cases, it can play a role to manage encoder, this address can be manually changed, and the default address is 192.168.1.168.



**Note: When accessing the device through a convenient managed IP address, your computer must have an IP address on the same network segment.**







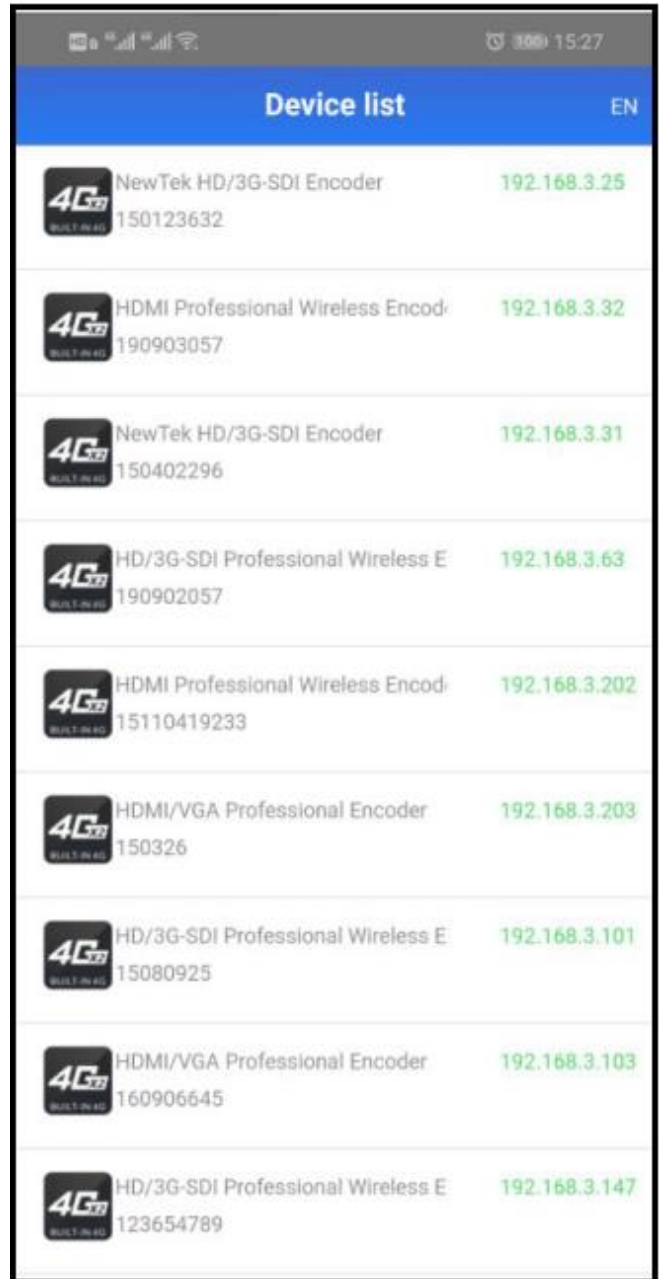

### 5.3.5 Android APP

- Please download the Android APP from Kiloview website.  
( <http://www.kiloview.com/companyfile/shi-pin-bian-ma-qi-Android-APP-45.html> )





- Connect the phone to the same network segment of the WIFI that the device connects. (You can share the hotpots while using P and G series encoder, please refer to 5.3.2 for details) Open the APP and search the connected devices under the same network segment automatically in the device list.
- The device information shown in the list includes device interface information, device serial number, device IP address, etc.
- Click your device from the device list to enter into management page.

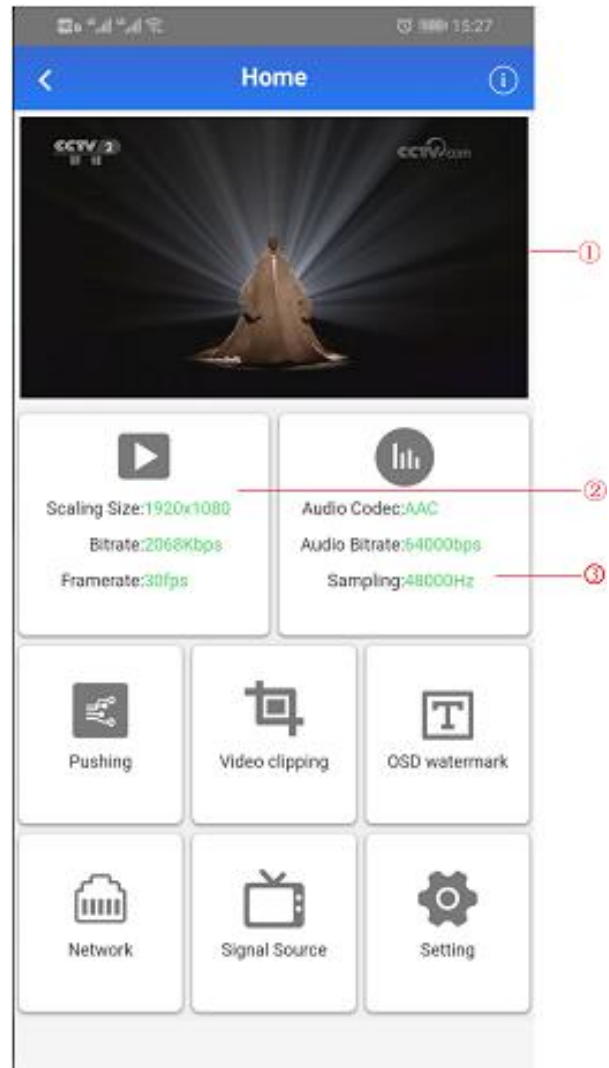

Device list		EN
	NewTek HD/3G-SDI Encoder 150123632	192.168.3.25
	HDMI Professional Wireless Encod 190903057	192.168.3.32
	NewTek HD/3G-SDI Encoder 150402296	192.168.3.31
	HD/3G-SDI Professional Wireless E 190902057	192.168.3.63
	HDMI Professional Wireless Encod 15110419233	192.168.3.202
	HDMI/VGA Professional Encoder 150326	192.168.3.203
	HD/3G-SDI Professional Wireless E 15080925	192.168.3.101
	HDMI/VGA Professional Encoder 160906645	192.168.3.103
	HD/3G-SDI Professional Wireless E 123654789	192.168.3.147

- On the configuration page, it shows video source image on the area of ① to monitor whether video source is normal. This image stream is refreshed in three seconds.
- Click ② for main stream configuration (Please refer to 6.4.2).
- Click ③ for audio encoding configuration (Please refer to 6.4.1).
- Click “Pushing” for stream service configuration (Please refer to 6.4.3).
- Click “Video Clipping” for video clipping function.
- Click “OSD watermark” for image overlay function configuration. APP only supports text and time overlay configuration, image overlay is configured on Web page (Please refer to 6.7).
- Click “Network” for network configuration (Please refer to 5.3).
- Click “Signal Source” for audio and video source choice page (Please refer to 6.3).
- “Setting” is used for quick reset, device reboot, restoring factory settings and device name modifications.



Click  and enter into device information page.

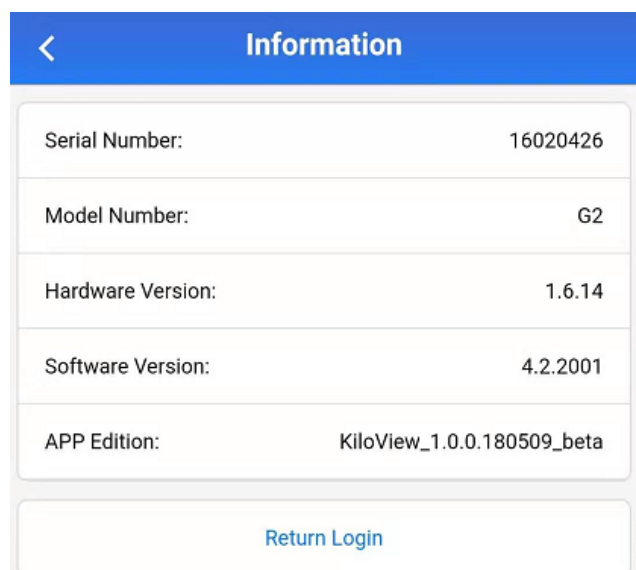

## 6 Parameters configuration

### 6.1 Dashboard

“Dashboard” is an overview of the current running status of the device and the status of audio and video streams. Users can click the “Refresh” button to refresh in real time, which can greatly help the encoder setting and troubleshooting.

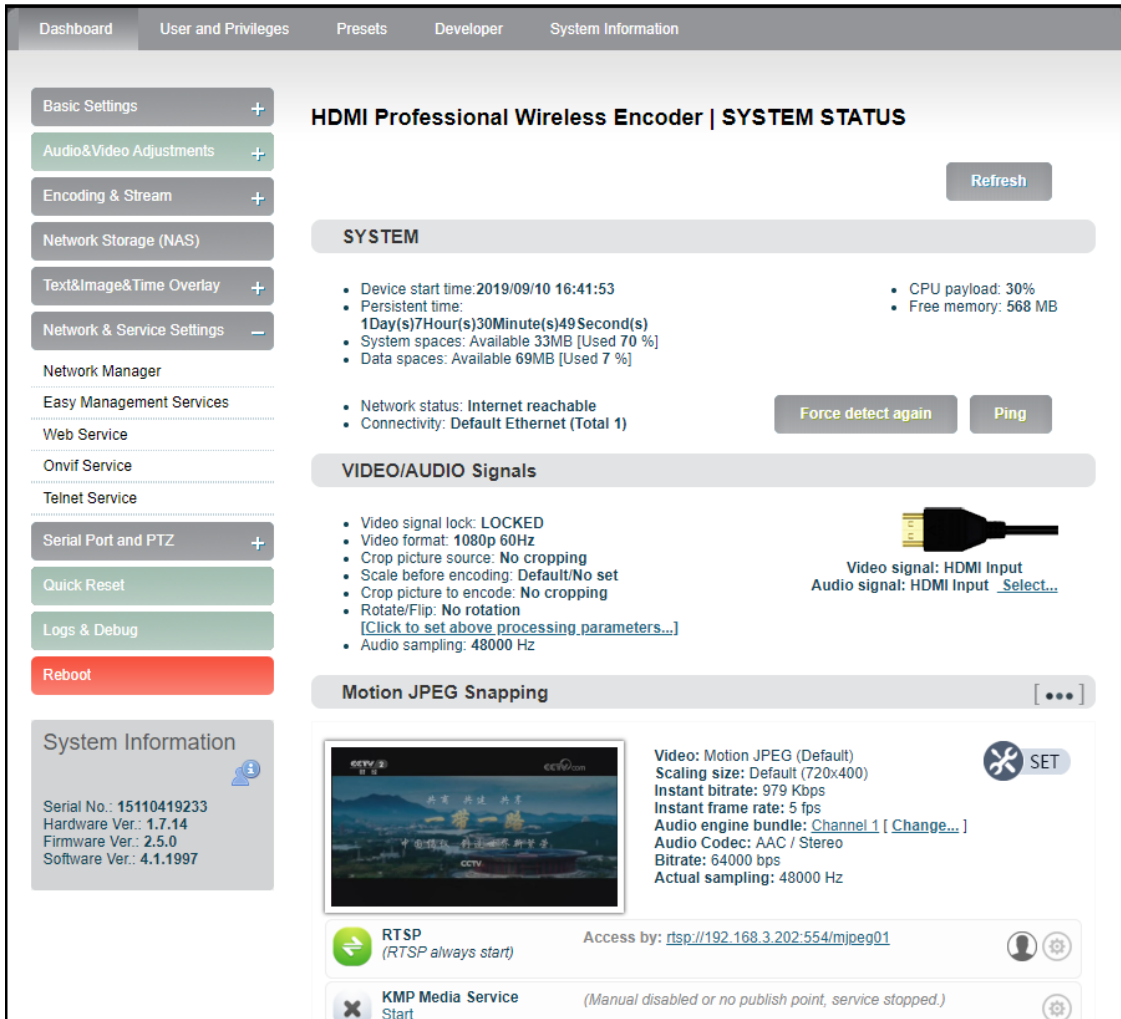

The screenshot displays the 'HDMI Professional Wireless Encoder | SYSTEM STATUS' dashboard. It features a left sidebar with navigation options like 'Basic Settings', 'Audio&Video Adjustments', and 'Reboot'. The main content area is divided into several sections:

- SYSTEM:** Shows device start time (2019/09/10 16:41:53), persistent time (1Day(s)7Hour(s)30Minute(s)49Second(s)), system spaces (Available 33MB [Used 70 %]), and data spaces (Available 69MB [Used 7 %]). It also indicates CPU payload (30%) and free memory (568 MB).
- VIDEO/AUDIO Signals:** Lists video signal lock (LOCKED), video format (1080p 60Hz), crop picture source (No cropping), scale before encoding (Default/No set), crop picture to encode (No cropping), rotate/flip (No rotation), and audio sampling (48000 Hz). It shows the video signal as HDMI Input and audio signal as HDMI Input.
- Motion JPEG Snapping:** Displays video settings such as Motion JPEG (Default), scaling size (Default 720x400), instant bitrate (979 Kbps), instant frame rate (5 fps), audio engine bundle (Channel 1), audio codec (AAC / Stereo), bitrate (64000 bps), and actual sampling (48000 Hz).
- RTSP:** Shows the RTSP stream URL: `rtsp://192.168.3.202:554/mjpeg01`.
- KMP Media Service:** Shows the service is disabled or stopped.

#### ● System

Click “Basic Setting”, users can know information including “device start time”, “persistent time”, “system spaces”, “data spaces”, “network status” and “connectivity” of the device, and go for “Ping” testing. If users need to push to Internet platforms, network status should be “Internet reachable”, or it cannot push streams.

The “Ping” provides a simple function to test whether the network is reachable. Open the “Ping” button, enter the test address, click “Ping”, wait for 3s, and “Connectivity” is displayed as “reachable, packet loss rate 0%” means the network is good and streams can be pushed to the Internet normally.



**⚠️ Note:** If Ping public IP address is reachable, but Ping domain name is unreachable. Generally, it is because the DNS server configuration is incorrect.

● Video/Audio signals

It can show “Video/audio signal”, “video format”, “preprocessing”, “audio sampling” as below:

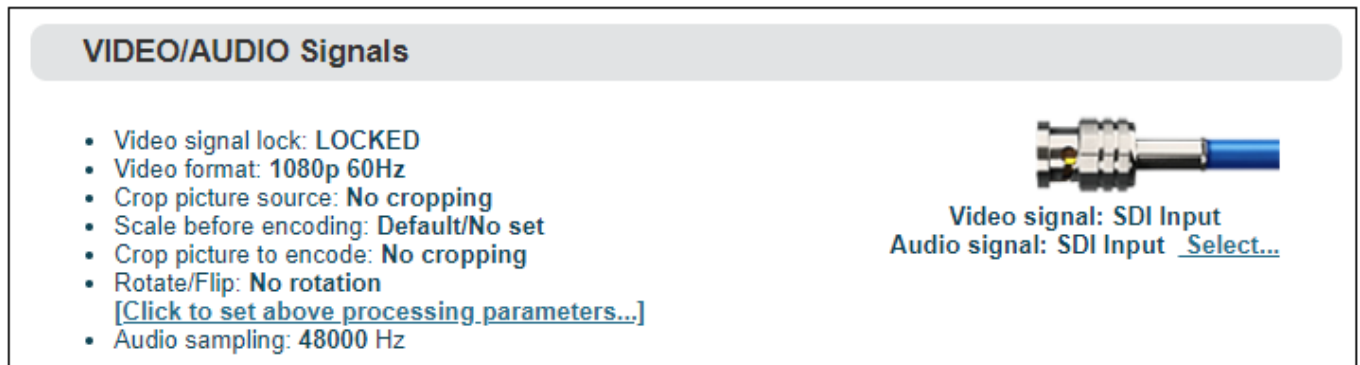

If “video signal lock” displayed as “no signal (display blue screen)”, it means the video input source is not detected by the device. Please check if the input cable is plugged in. If “Audio sampling” is displayed as “0Hz”, the audio signal is not collected on the device. Please check if the audio of the input source is normal.

## 6.2 Basic settings

Users can go for some basic functions settings here.

### 6.2.1 Change WEB login password

Click “Change Password”, an option box will pop up, users can modify the WEB login password, the default password is admin.



### 6.2.2 Location and time

Click “location and time”, then users can modify system time of the encoder, or just select “Synchronize from this PC”.

#### Location & Time Setting

---

**i** Current time of device: 2019-07-03 19:31:18  
Universal Coordinated Time in Device: 2019-07-03 11:31:18

Location/Time zone: Asia/Shanghai  
NTP Time Synchronization Enable: yes  
NTP Synchronization Status: yes

#### Select Your Location



Location/Time zone: Asia/Shanghai, Beijing

Country/Area: China

#### Date & Time Setting

Set: Synchronize From NTP Server

NTP Server: NTP Server on Internet - China



### 6.2.3 Restore factory settings

If users change parameters that lead encoder couldn't work (Typical situation is that encoder couldn't be visited by network after modifying network address), users could restore factory settings to default value.

Two methods for restoring factory settings:

1. Via the WEB interface, "Basic Setup > restore factory settings" function;
2. Through RESET button:

On the dashboard, there is a button of . Pressing on RESET button for 3 seconds, device will restore factory settings. Restoring factory setting will lead to the device hard restart, restarting course will last 1 minute.

Please note: after restoring factory setting, below parameters will be changed to default value:

- Login username and password will be admin;
- IP address will be restored as 192.168.1.168; subnet mask will be 255.255.255.0;
- All encoding parameters of video and audio will be restored to factory default value;
- Media transmission parameters will be restored as factory default value.

### 6.2.4 Firmware upgrading

The encoder supports online firmware upgrading. Through the "Basic Settings-Firmware Upgrade" of the Web page, users can upload the firmware online. Click "Select Files" to select the upgrade file, and click "Upgrade" to upgrade the device. The upgrade process is slow, around 30s to 1 minute, please be patient.

#### Firmware and software upgrading



**Current Firmware Version: 2.5.0**  
**Current Software Version: 4.1.1997**  
**Device Serial No: 15110419233**

Please check the device type and software/firmware version is correct before upgrading. Upload the firmware bellow.  
**NOTE: It need reboot the device to finish the upgrading while firmware uploaded!**



Upload Firmware:  No file chosen

## 6.3 Video & Audio adjustments

### 6.3.1 Video source choice and adjustments

Users can choose video source, adjust brightness, contrast, saturation and hue parameters of the video here.

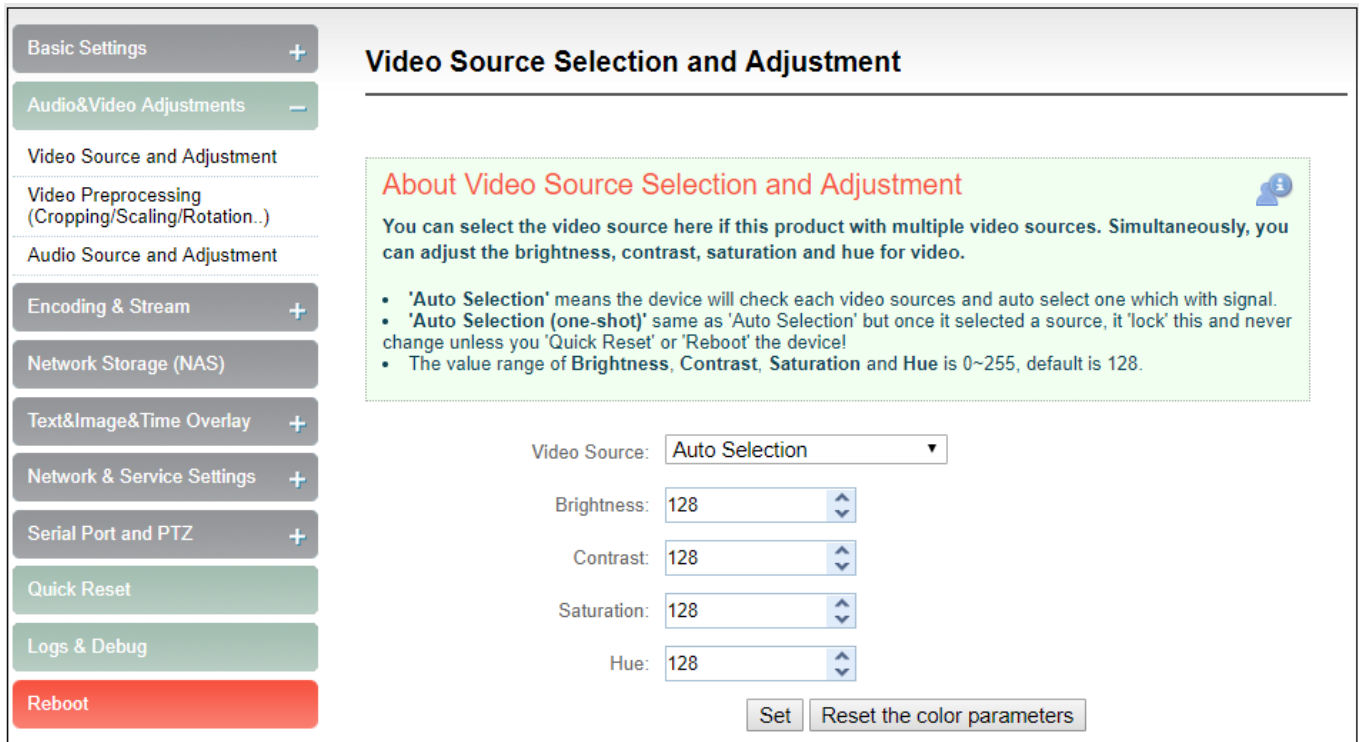

**Video Source Selection and Adjustment**

**About Video Source Selection and Adjustment**

You can select the video source here if this product with multiple video sources. Simultaneously, you can adjust the brightness, contrast, saturation and hue for video.

- 'Auto Selection' means the device will check each video sources and auto select one which with signal.
- 'Auto Selection (one-shot)' same as 'Auto Selection' but once it selected a source, it 'lock' this and never change unless you 'Quick Reset' or 'Reboot' the device!
- The value range of Brightness, Contrast, Saturation and Hue is 0~255, default is 128.

Video Source: Auto Selection

Brightness: 128

Contrast: 128

Saturation: 128

Hue: 128

Set Reset the color parameters

“Auto Selection” means the device will check each video source and automatically select the one which has signal.

“Auto Selection (one-shot)” same as “Auto Selection” but once it selected a source, it 'lock' this and never change unless you 'Quick Reset' or 'Reboot' the device!

The value range of Brightness, Contrast, Saturation and Hue is 0~255, default is 128. Based on the median value, the increase/decrease value corresponds to the increase/decrease in brightness/contrast/saturation. The default value of Hue is 128, which represents phase 0; the value range is 0-255.

### 6.3.2 Video preprocessing

Before video captured and sent to encoder, we can make some necessary preprocessing:

- (1) Source picture cropping: Crop a part of the original picture for encoding.
- (2) Scaling: After step 1 cropping (or not cropping), video can be scaled up/down to certain format. (E.g. Input video is 1080p60, scaling down to 720p30 for encoding.)
- (3) Second cropping: After the step 2, you can continue cropping the size you want for encoding. (It's almost the same with step 1, but necessary in specific application.)
- (4) Rotation or flipping: It's the last step before encoding, you can rotate the video with 90/180/270 degrees, horizontal mirror or vertical flip.

Above process is a pipeline from step 1 to step 4. You could choose to open, or prohibit it about each step.

Source Picture Cropping:



Scale To:







DEFAULT



Cropping The Scaled Picture:



Rotation/Flipping:

		
Default	90 Deg.	180 Deg.
		
270 Deg.	Mirror	Flip

### 6.3.3 Audio signal source

Audio source “Auto selection” mode is automatically to select the embedded audio of the input video source.

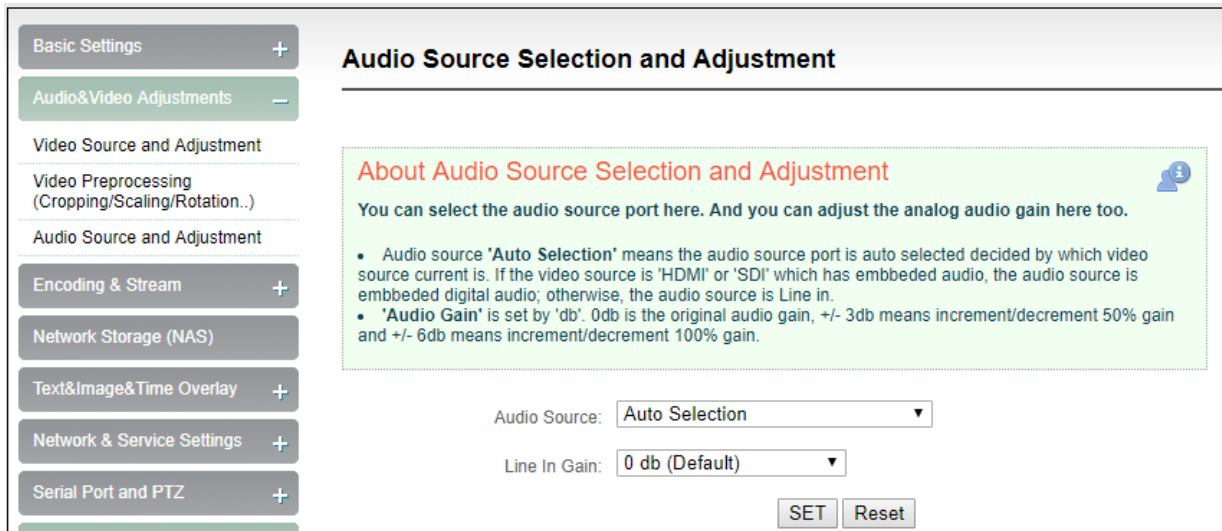

## 6.4 Encoding & Steam

### 6.4.1 Audio encoding parameter setting

Encoders can set audio encoding parameters. Click “Encoding &stream”, pull downward “Audio Encoding Engine”, then entering into audio parameters setting. Audio encoding channel is forced to enable. Audio encoding modes include AAC and G.711, optional. Audio sampling is chosen according to actual situation. Channels consist of “Stereo” and “Mono”. Encoding bitrate is adjustable between 16K-256K, default is 64Kbps. One more detail: if encoder using TS-UDP protocol or needs using recording, then it needs to choose “With ADTS header” under AAC format.

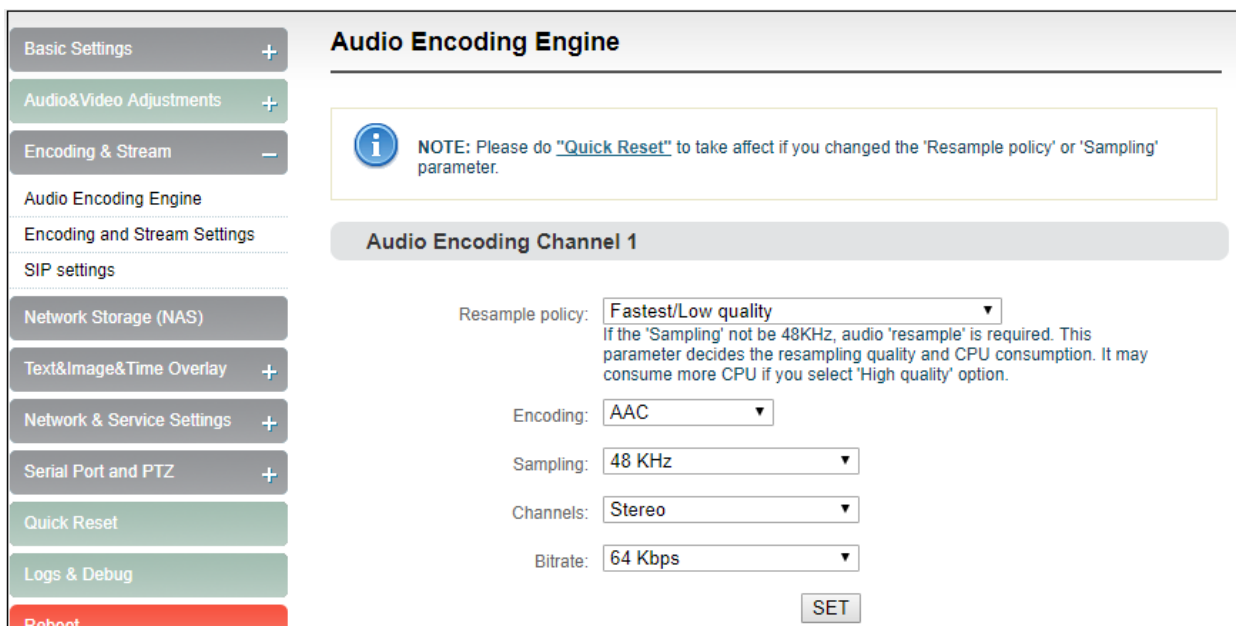

 **Note: Please do "Quick Reset" to take affect if you changed the 'Resample policy' or 'Sampling' parameter.**

## 6.4.2 Encoding and stream settings

Video encoding parameters are adjustable. Click “Encoding &Stream”, pull downward “Encoding and stream settings” to enter below interface. We generally set parameters of “H.264 main stream”, click “Setting”.

**Note: It is H.264 Main stream, the second setting, not Motion JPEG setting.**

Basic Settings +

Audio&Video Adjustments +

Encoding & Stream -

Audio Encoding Engine

Encoding and Stream Settings

SIP settings

Network Storage (NAS)

Text&Image&Time Overlay +

Network & Service Settings +

Serial Port and PTZ +

Quick Reset

Logs & Debug

Reboot

---

System Information

Serial No.: 184123456  
 Hardware Ver.: 1.2.20  
 Firmware Ver.: 2.5.0  
 Software Ver.: 4.00.1995

### Encoding and Stream

[Refresh](#)

Motion JPEG Snapping [ ... ]

Video: Motion JPEG (Default)  
 Scaling size: Default (720x400)  
 Instant bitrate: 1186 Kbps  
 Instant frame rate: 5 fps  
 Audio engine bundle: [Channel 1](#) [ [Change...](#) ]  
 Audio Codec: AAC / Stereo  
 Bitrate: 64000 bps  
 Actual sampling: 48000 Hz

SET

**RTSP** Access by: <rtsp://192.168.3.155:554/mjpeg01>

*(RTSP always start)*

**KMP Media Service** *(Manual disabled or no publish point, service stopped.)*

[Start](#)

H.264 Main Stream [ ... ]

Video: H.264 (High Profile)  
 Scaling size: Default (1920x1080)  
 Instant bitrate: 9627 Kbps  
 Instant frame rate: 60 fps  
 Audio engine bundle: [Channel 1](#) [ [Change...](#) ]  
 Audio Codec: AAC / Stereo  
 Bitrate: 64000 bps  
 Actual sampling: 48000 Hz

SET

Version 1.1 © Changsha KILOVIEW Electronics CO., LTD. All rights reserved

9

Click SET, entering into below interface for main streaming encoding parameters setting, as follows:

### Main Stream Encoder parameters

---

Scaling:

Color:

H.264 profile:

Bitrate control:

Bitrate:  bps

Bitrate auto adjust:

Framerate:

Dynamic framerate:

GOP Size:

Customized GOP size:

Reference frames:   
(Using multiple reference frames should better encoding quality but this may be not compatible to some decoders)

“Scaling” has 9 options for choice. Default setting is “Default size”, that is, the video size after encoding is the same as the input video size.

“Color” has two options: “With color and monochrome”. Monochrome is black and white color, “with color” remains the original color. Default setting is “With color”.

“H.264 Profile” supports High profile, main profile, baseline, which is set according to platform supported encoding profile. High Profile is the highest compression efficiency, that is, under the same bitrates, image quality is the best; Baseline is the most widely supported; default setting is High Profile.

“Bitrate control” has two ways: CBR-Constant bitrate and VBR-Variant bitrate. From literal meaning, CBR is stable and unchanged bitrate, while VBR is constantly changing according to actual content. Generally, network transmission adopts CBR to guarantee transmission quality, while file storage uses VBR to guarantee file quality. Default setting is CBR-Constant bitrate.

“Bitrate” supports adjustable 64K-25M. Users could choose default setting, or self-define bitrate size. The higher bitrates, video quality after encoding is better. But specific setting should be based on actual network situation, couldn’t be higher than your own upstream bandwidth.

“Framerate” has three options: FULL (same as input source, HALF (half when source framerate $\geq$ 50 and customized framerate. “FULL” means framerate after encoding is the same as the framerate of input source; “HALF” means if input video is 1920\*1080P50, video framerate after encoding will be 25. This will be a good saving on the consumption of network bandwidth; customized framerate is user assigning framerate after encoding, in theory, it shouldn’t be higher than original framerate.

“GOP size” has five options and supports user-defined adjustment. It is adjustable according to actual situation, default is 60, and normally it could meet the most majority of needs.

“Reference frames” has two options: one and multiframe. Theoretically using multiframe can improve encoding quality, but some decoders and players may not support multiframe.

**Sub stream parameter setting refers to Main stream configuration.**

### 6.4.3 Streaming media service

Encoder currently support streaming services include: RTSP, RTMP push, HLS service, TS-UDP push ,SRT push, Onvif service. One code stream can run up to 8 stream services at the same time for the encoder, which means it can push the video stream to 8 different live platforms. There are two code streams (the main stream and sub stream) for the encoder, so the encoder can stream up to 16 different live platforms at the same time. In general, the main stream is enough, and the sub stream is mainly used in the security monitoring field to achieve the docking usage with the NVR.

#### 6.4.3.1 Motion JPEG stream

Encoder has a Motion JPEG stream, it keeps running without stop. It is blank with blue color if without video access. If with a video signal access, Motion JPEG stream will display the content of current flow, “the video signal lock” displays locked and it will display the current video signal format.

**Motion JPEG Snapping**
[ ... ]



**Video:** Motion JPEG (Default)  
**Scaling size:** Default (720x400)  
**Instant bitrate:** 1603 Kbps  
**Instant frame rate:** 5 fps  
**Audio engine bundle:** [Channel 1 \[ Change... \]](#)  
**Audio Codec:** AAC / Stereo  
**Bitrate:** 64000 bps  
**Actual sampling:** 48000 Hz

SET

 **Note:** Motion JPEG stream is a picture preview, refresh every 3 seconds, or click the mouse to refresh, so it is normal to see it is not fluent on the page.

#### 6.4.3.2 RTSP service

RTSP service cannot stop when encoder runs. It will not have additional load on the encoder if the stream is not pulled for decoding. As shown in the red frame, the RTSP service flow address is "rtsp://192.168.1.168:554/ch01". "192.168.1.168" is the IP address of the encoder, If the for encoder, the IP address is 192.168.2.168, then the RTSP service address is "rtsp://192.168.2.168:554/ch01", if there are several IP encoding device, these IP address can also directly pull RTSP flow accordingly.



H.264 Main Stream
[ ... ]

Video: H.264 (High Profile)  
 Scaling size: Default (1920x1080)  
 Instant bitrate: 1907 Kbps  
 Instant frame rate: 30 fps  
 Audio engine bundle: Channel 1 [ [Change...](#) ]  
 Audio Codec: AAC / Stereo  
 Bitrate: 64000 bps  
 Actual sampling: 48000 Hz

SET

Record
Stopped

[Start Record](#)

RTSP
Access by rtsp://192.168.3.202:554/ch01

(RTSP always start)

Normally VLC media player is used to decode and play the video stream. Open VLC media player, select the "media", and "open network stream", then enter the RTSP service URL address, you can play the video.

Open Media
— □ ×

File
 Disc
 Network
 Capture Device

Network Protocol

Please enter a network URL:

rtsp://192.168.3.202:554/ch01

<http://www.example.com/stream.avi>  
<rtp://@:1234>  
<mms://mms.examples.com/stream.asx>  
<rtsp://server.example.org:8080/test.sdp>  
<http://www.youtube.com/watch?v=gg64x>

Show more options

Play ▾
Cancel

**Note:** URL should be copied completely and the punctuation marks should be included.



### 6.4.3.3 RTMP Pushing (Live streaming)

Using RTMP pushing, the first thing is to make sure platform providing RTMP pushing address, otherwise our encoders couldn't do RTMP pushing (Currently some live streaming APP couldn't provide RTMP pushing address.)

**Note:** The principle of RTMP push stream is that it must be pushed from the encoder to the platform. The computer/decoder then pulls the RTMP stream from the platform for playback. The encoder cannot directly push the RTMP stream to the computer/decoder for playback.

#### YouTube live streaming

"Streaming point" is RTMP address given by platform (Take YouTube as an example). (Other platforms are similar, if any questions please contact platform technical support for help).

1) Login to YouTube, get below address:

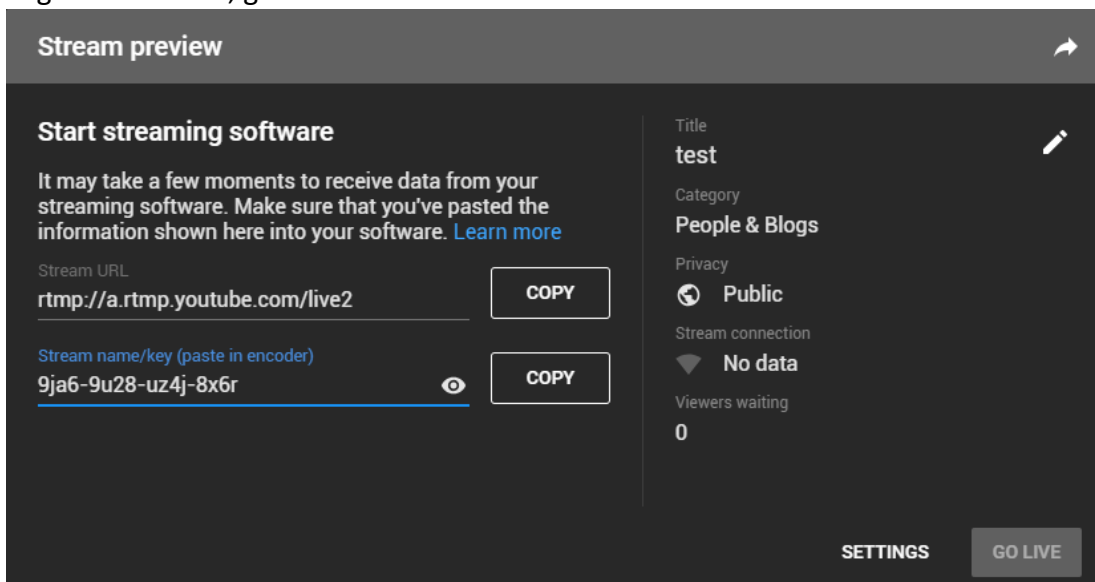

Streaming point should be like Server URL+Stream name/key.

For example: `rtmp://a.rtmp.youtube.com/live2/9ja6-9u28-uz4j-8x6r`

2) After you get the RTMP URL address, you need to set it up in the encoder. In the main stream of H.264, there is a stream service option to be added. By adding a RTMP push, you can get a RTMP push option. Click the settings button on the right side of the RTMP push, and you will enter the interface to fill in the RTMP push configuration. The push address on YouTube platform is filled in the "push point", and set "Enable pushing" to "Yes". Click "Save", then RTMP will stream to YouTube.

### Main Stream RTMP pushing parameters

---

Enable pushing:

Push point:

Username:

Password:

Connection timeout (s):

Connection retry interval (s):

Use old RTMP version:   
(After version 3.99, a new RTMP pushing software is used, this is compatible with more RTMP servers. But if the new version has any problem, you can try use old RTMP version which is used before version 3.99)

Insert NTP timestamp:   
You must set 'Use old RTMP version' to be 'Yes' to enable this feature. And don't forget enable NTP time synchronization if you need the NTP timestamp insertion

If the platform requires user name and password verification, you also need to fill in the corresponding parameters in the encoder.

- 3) On YouTube platform, if the video can be displayed, the push stream is successful; otherwise you need to check the network and other configurations.

---

** Note: In the case of RTMPS push mode, fill in RTMPS URL at Push point and set 'Use old RTMP version' to yes, so that it can be supported.**

---

### 6.4.3.4 TS-UDP Pushing (unicast and multicast)

Click  [Add a stream...](#) to select TS-UDP Pushing, then entering into TS-UDP setting interface.

TS-UDP pushing divides into unicast and multicast. If using unicast, “pushing target address” is device IP address of receiving TS streaming. “Target port” is any port, but it is better not conflicted with other service port. No need to change Multicast TTL; If using multicast, “pushing target address” needs to write a correct multicast address (224.x.x.x ~ 239.x.x.x). “Target port” is any port, but it is better not conflicted with other service port.

#### Main Stream TS pushing parameters

---

Enable pushing:

Target Address:   
( Target IP address or multicast IP address. A valid multicast address is 224.x.x.x ~ 239.x.x.x )

Target Port:

Multicast TTL:   
( TTL is valid when target address is a multicast address. TTL decides how many routers the multicast packet can pass through. )

TS advanced settings Below are some TS advanced options, if you are not sure how to set these, just please use default settings

NULL packets:

Stream ID:   
(1-65535)

PTS to PCR delay:

PMT start PID:   
(16-7936)

Stream start PID:   
(32-3840)

Tables version:   
(0-31)

Service name:

Service provider:

















After finishing setting, it will come up an URL address from TS-UDP pushing, which could be decoded through VLC or other decoding player. If it is multicast, please remember to close Windows firewall.

H.264 Main Stream [ ... ]



Video: H.264 (High Profile)  
 Scaling size: Default (1920x1080)  
 Instant bitrate: 9384 Kbps  
 Instant frame rate: 60 fps  
 Audio engine bundle: [Channel 1](#) [ [Change...](#) ]  
 Audio Codec: AAC / Stereo  
 Bitrate: 64000 bps  
 Actual sampling: 48000 Hz

 SET

	Record <a href="#">Start Record</a>	Stopped	 
	RTSP <i>(RTSP always start)</i>	Access by: <a href="rtsp://192.168.3.155:554/ch01">rtsp://192.168.3.155:554/ch01</a>	 
	KMP Media Service <a href="#">Start</a>	<i>(Manual disabled or no publish point, service stopped.)</i>	
	HLS Service <a href="#">Stop</a>	Publish point: <a href="http://192.168.3.155/hls/main/playlist.m3u8">http://192.168.3.155/hls/main/playlist.m3u8</a>	 
	RTMP Pushing <a href="#">Start</a>	<i>(Manual disabled or no publish point, service stopped.)</i>	 
	TS-UDP Pushing <a href="#">Stop</a>	Publish point: <a href="udp://225.225.5.5:5678">udp://225.225.5.5:5678</a>	 

 [Add a stream...](#)

 **Note:** When the URL obtained by configuring multicast push mode is `udp://225.225.5.5:5678`, if played by VLC Player, it needs to add @ for playing, that is `udp://@225.225.5.5:5678`.

### 6.4.3.5 HLS service

Using HLS service, the first thing is to “add a stream service”, then click right-side SET icon of “HLS service” for setting.

Below is setting interface of HLS service. Very simple, if no special requirements, no need setting, only enable service.

### Main Stream HLS service parameters

---

Enable Service:

Session ID:   
( Session ID is the unique identifier for HLS services, it can not be empty )

Segment Size:

Once enabling service, it will get one HLS Publish point. You could watch it through VLC and other players using this address.











**H.264 Main Stream** [ ... ]



Scene \_\_\_\_\_  
Cut \_\_\_\_\_

**Video:** H.264 (High Profile)  
 Scaling size: Default (1920x1080)  
 Instant bitrate: 9759 Kbps  
 Instant frame rate: 60 fps  
**Audio engine bundle:** [Channel 1](#) [ [Change...](#) ]  
 Audio Codec: AAC / Stereo  
 Bitrate: 64000 bps  
 Actual sampling: 48000 Hz



	<b>Record</b> <a href="#">Start Record</a>	Stopped	 
	<b>RTSP</b> (RTSP always start)	Access by: <a href="rtsp://192.168.3.155:554/ch01">rtsp://192.168.3.155:554/ch01</a>	 
	<b>KMP Media Service</b> <a href="#">Start</a>	(Manual disabled or no publish point, service stopped.)	
	<b>HLS Service</b> <a href="#">Stop</a>	Publish point: <a href="http://192.168.3.155/hls/main/playlist.m3u8">http://192.168.3.155/hls/main/playlist.m3u8</a>	 

6.4.3.6 SRT-TS pushing

- 1) Click “Encoding & Stream”—“Encoding and Stream Settings”—“H.264 main stream”—“Add a stream”. Choose “SRT-TS pushing”, click “OK” and add a SRT service.

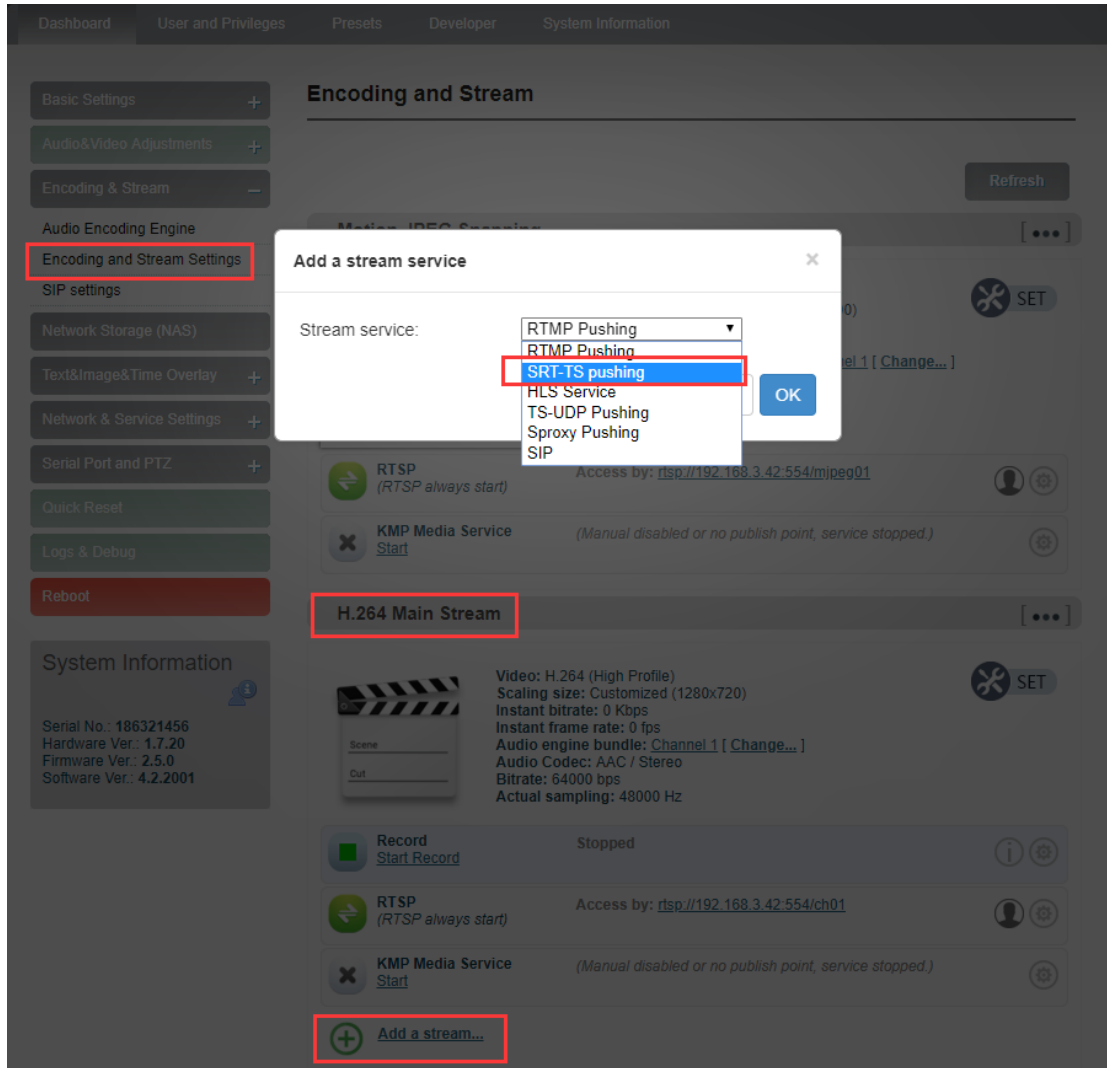

- 2) Click the icon  for SRT configuration.

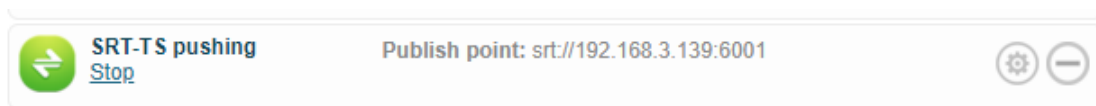

3) Fill in the pushing address and port, click “Save”. Then SRT pushing is working.

### Primary Stream SRT-TS Pushing Parameters

---

Open SRT service

Handshake Mode

Address

Port   
( Please fill in the value of 0-65536 )

Transport Delay(ms)   
(Please fill in the value of 0-5000 )

Advanced Settings

Encryption mode

AES Key   
(Please fill in 10-32 letters or numbers.)

Bandwidth Overhead(%)   
(Please fill in the value of 0-100 )

Load Size   
(Please fill in the value of 0-1456 )

Handshake mode: Caller、Listener、Rendezvous;

Address: Set IP address of the receiving port;

Port: Set the listening port corresponding to the receiving port;

Transport delay: Set it based on the performance of the current network, the delay value can be set on both the SRT source device and the SRT target device. The final SRT transmission delay will be the larger one of the two values. Default is 125ms;

Advanced settings: Open and Close;

Encryption mode: AES-128, AES-192, AES-256;

AES key: encryption AES key can be 10-32 letters or numbers combination;

Bandwidth overhead: It is set as the percentage value based on network link quality. Using this value to multiply the total bitrate of the audio and video encoded by the encoder, this will get the occupied maximum bandwidth allowed by Bandwidth Overhead. This value plus the total of video and audio bitrate is the threshold of the current SRT transmission bandwidth, and also the maximum bandwidth that SRT stream can be used. From the perspective of "overhead", it is the extra "invalid" bandwidth to be used in addition to the media content required for transmission (which can be understood as the payload), but it is different from our common protocol overhead, TCP header overhead, UDP header overhead. The bandwidth overhead here is not a fixed 20~60 bytes TCP header overhead or 8 bytes UDP header overhead. It changes in real time according to the network conditions. The worse the network link conditions are, the more overhead needs for normal transmission. The range is 5%~100%, and the default overhead is 25%;

Load size: Sending data packet size, it is optimal that the receiving port should equip with the same size. The default size is 1316, the optimal packet for the codec.

Network highest packet loss rate (%)	RTT Multiplier	BW Overhead	The lowest SRT delay (when RTT ≤ 20ms)
≤ 1	3	33	60
≤ 3	4	25	80
≤ 7	5	20	100
≤ 10	6	17	120

**Note:** Below format is the reference delay value under different packet loss. When RTT > 20ms, it requires to increase the delay appropriately.

- Save the settings, then a SRT-TS pushing address will be added. The encoder starts to initiate a handshake connection to the receiving port.

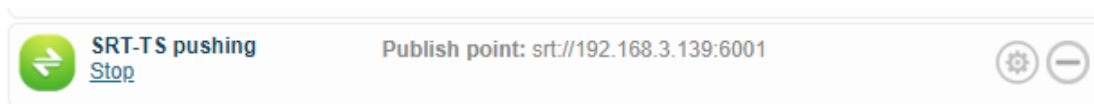

## 6.5 Local recording

Encoders support local recording function. Encoder with TF card-slot can support TF recording and meanwhile it supports USB disk inserted into USB port of encoder for recording. The recording operation is as follows:

- Click “Record” below “H.264 Main Stream” under “Dashboard” or “Encoding and stream setting”.

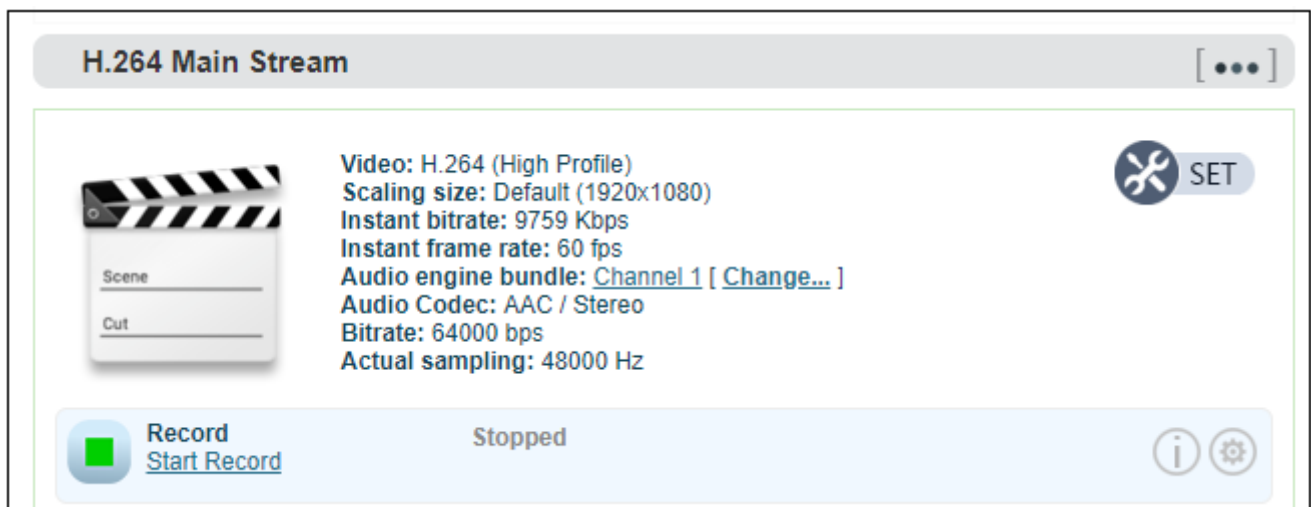



- 2) Click  "Record settings" icon for setting

### Main Stream Record Settings

---

**About Record**

Set the record parameters here.

**Why the default format is 'TS':** If you removed USB or SD/MMC disk while recording, a terrible thing may happen that is the recorded file may be wrong and can not play anything, if the file format is '.avi' or '.mp4', etc. But 'TS' format can avoid this, also, the 'TS' format is compatible with almost modern media players.

**DON'T use the NTFS!** This device can support NTFS file system, but no suggest to use it! The NTFS filesystem can cause high CPU using and affect other streaming functions. If you force to use NTFS, please set the encoding bitrate lower than 8Mbps.

After changed the record settings, it can only take effect in next starting record time!

(Plug in disks) Auto record:

Disk Selection:   
Use the largest disk to record files, never care what disk type it is.

Record Format:

Filename Prefix:

File Limitation:

Size Limitation:  KB

Overwrite:

 **Note:** A real challenge for recording by removable disks: If you remove the storage disk while recording, the recorded file may be wrong and can not be played if the file format is '.avi' or '.mp4', etc. But 'TS' format can avoid this, also, the 'TS' format is compatible with almost all the main media players.

**If recording is performed in a non-TS format, when the recording is completed, stop the recording manually, and then remove the storage device to ensure the recording can be played normally.**

- 3) By default, it automatically starts recording when storage disks inserted, regardless its storage type. It will record to the biggest available storage area. Recording format is TS file by default. Users could set recording for automatic cutting based on specified size. And when storage space is insufficient, it will automatically overwrite the old video file to achieve redundant storage.

4) Click to check recording status and record list.

- When no disks inserted or NAS network storage not set, the status will be as follows , dashboard will show “Stopped”.

H.264 Main Stream
[ ... ]





Video: H.264 (High Profile)  
 Scaling size: Default (1920x1080)  
 Instant bitrate: 18 Kbps  
 Instant frame rate: 25 fps  
 Audio engine bundle: [Channel 1 \[ Change... \]](#)  
 Audio Codec: AAC / Stereo  
 Bitrate: 64000 bps  
 Actual sampling: 48000 Hz

 SET

Record  
[Start Record](#)

Stopped

Record status shows “No valid disks” and “No records”.

### Main Stream - Record Status

Refresh

All Disks

(No valid disks)

Record List

(No records)

- After inserted disks, the encoder will start recording automatically and the dashboard shows “Recording”.

H.264 Main Stream
[ ... ]





Video: H.264 (High Profile)  
 Scaling size: Default (1920x1080)  
 Instant bitrate: 18 Kbps  
 Instant frame rate: 25 fps  
 Audio engine bundle: [Channel 1 \[ Change... \]](#)  
 Audio Codec: AAC / Stereo  
 Bitrate: 64000 bps  
 Actual sampling: 48000 Hz

 SET

Record  
[Stop Record](#)

Recording (TO: USB Storage, FORMAT: ts)  
 [ Files: 1, Total Size: 0 KB, Times: 0:00:08 ]

The "Video Status" is shown below, where you can view the usage of the memory or downloads the video files that have been stored in the memory to the computer.

### Main Stream - Record Status

Refresh

**All Disks**

**WIN10 [vfat]**

Total: 29.46 GB, Free: 25.7 GB

Used: 13%

**Record List**

FILE: REC-20190704151459.ts 291.51 MB [Download](#)

Sequence: M-20190704\_151459\_0000 [CURRENT RECORDING]

Start time: 2019-07-04 15:15:11, End time: 2019-07-04 15:18:41; FILES: 1, Total Size: 291.51 MB

FILE: REC-20190702105851.ts 79.49 MB [Download](#)

- When it is recording, users can stop the recording manually and it can be restarted again.

**Note:** When recording with TF card, it only supports formats of NTFS, FAT32 or vfat. For TF cards over 64G, the default formatting is exFAT under the formatting program of Windows system, which may lead to the TF card unrecognizable.

Sometimes, due to the influence of some files or programs in the TF card, the TF card can not be recognized. You need to format the TF card once.

## 6.6 Network Storage (NAS)

NAS is a Disk Arrays connected by network; it has all the main characteristics of disk arrays: high capacity, high efficiency and high reliability.

Open NAS Manager, click “add NAS”, then fill in the corresponding parameters.

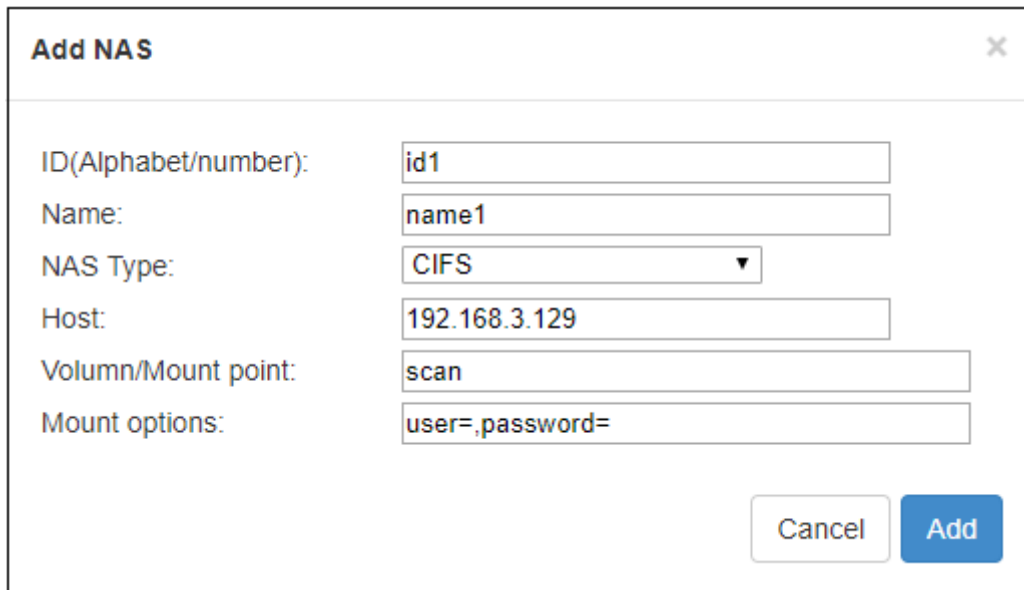

- ID/ Name: Any Alphabet/number.
- NAS Type: NFS or CIFS (CIFS is a shared protocol for network connection, which requires high reliability of network transmission, TCP/IP is usually adopted; NFS is transport-independent, TCP or UDP is adopted; One of the disadvantage of NFS is, it requires the user to install a special software, while CIFS is integrated inside the OS, and no additional software is needed.).
- Host: IP address of the Host.
- Volume/Mount point: Storage location on the host.
- Mount options: Settings about the user name and password.

NAS manager will show “Mounted” if NAS connection has been established, and there is a RECORD file under the Mount point. If the connection is abnormal, it will be displayed as “Mounting”.

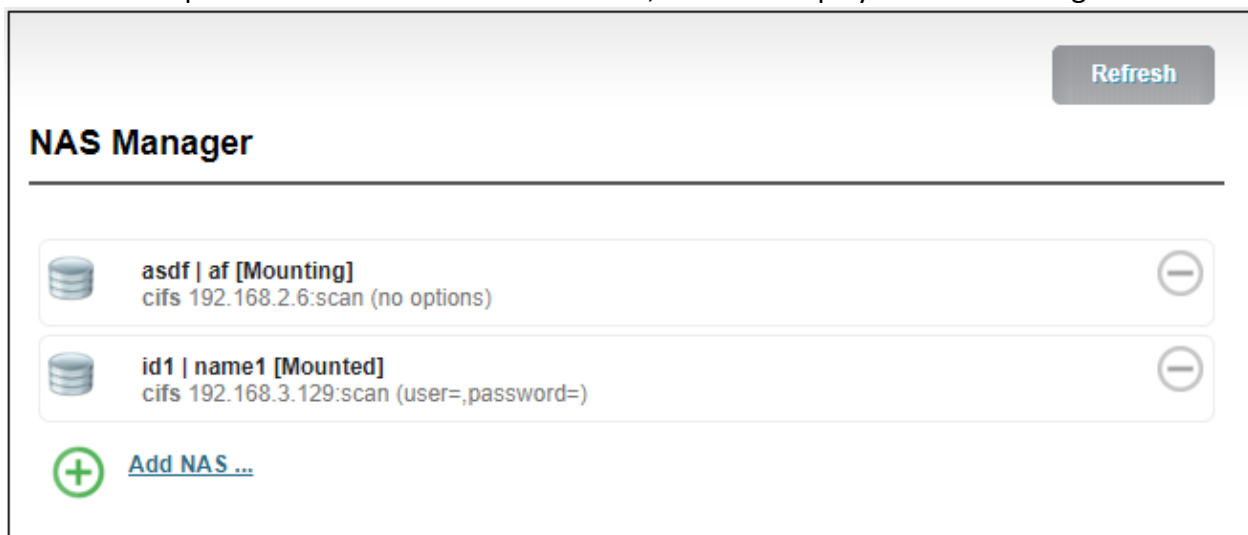

## 6.7 Text/ Image/Time overlay

Please open the “Overlay image management” to upload an image first if you want to make image overlay; if text or time overlay, you can set the overlay function directly.

### 6.7.1 Overlay Image Management

Enter “Image Management” ---fill in “Image ID-- Choose the image that you want—click “Add”, then image is uploaded to the Encoder storage. You can check the image and information listed under the Image list.

## Overlay Image Management

Upload an overlay image (JPEG or PNG)

i

Upload image:

Image ID(\*MUST):

Upload file:  No file chosen

Image list

Alpha blending: (Not set) [Set alpha...](#)

Overlay size: (238, 79) [Convert...](#)

Transparent color index: (No transparent color key)

Image ID: hello | Image type: png | Original size: 238x79

[Remove this image](#)

You can change the parameters after uploading the image

Set alpha blending: Value range is 0-255, 0 is full transparent and 255 is no alpha blending.

Convert:

- Image size: If width/height set to 0, it will overlay the image as original size.
- PNG transparent threshold: If the original PNG transparent level is less than the threshold value, overlay that area as full transparent. Set a reasonable value can make the image border be smooth.
- Transparent color index: Manually specify an index color to erase background. Set tolerance (0%~100%) to control the similar color range selection. In most cases, transparent PNG images do not need to be processed manually.

### 6.7.2 Overlay function

Go to the overlay settings page, in the settings of “Main stream”, please choose “open” to enable overlay, for “Don't rotate follow picture”, please choose yes or no .Then choose “Add overlay item” to set overlay functions for “Text”, “Time” and “Image” respectively. You can set multiple overlays at the same time.

### Text and Time Overlay

---

i
NOTE: If you require more fonts/languages support, please contact our technical support. We can customize more fonts/languages, by upgrading a language patch firmware.

**Main Stream Overlay**

Enable overlay for this stream:     Don't rotate follow picture:    

+ [Add overlay item...](#)

Add overlay item (text)

**Add Overlay Item**
×



---

Overlay Type	<input type="text" value="Text"/>
Show when:	<input type="text" value="Always"/>
Position	<input type="text" value="Left top"/>
Font	<input type="text" value="Default (En)"/>
Font Size	<input type="text" value="Auto - Medium"/>
Font Style	<input type="text" value="Normal"/>
Text Outline	<input type="text" value="2 px"/>
<b>Overlay Text:</b>	<input style="width: 100%;" type="text"/>

For every overlay, you can set the terms of overlay, position, font and font size, Image or text content and so on. After adding that, it will be shown as follows:

**Main Stream Overlay**

Enable overlay for this stream:  Don't rotate follow picture:

	Text At: Top center	HELLO	<input type="button" value="Settings"/> <input type="button" value="Close"/>
	Image At: Left top	PIC1	<input type="button" value="Settings"/> <input type="button" value="Close"/>
	System Time At: Right top	<Auto show system time>	<input type="button" value="Settings"/> <input type="button" value="Close"/>

[Add overlay item...](#)

After encoding, the overlay will be shown as follow:

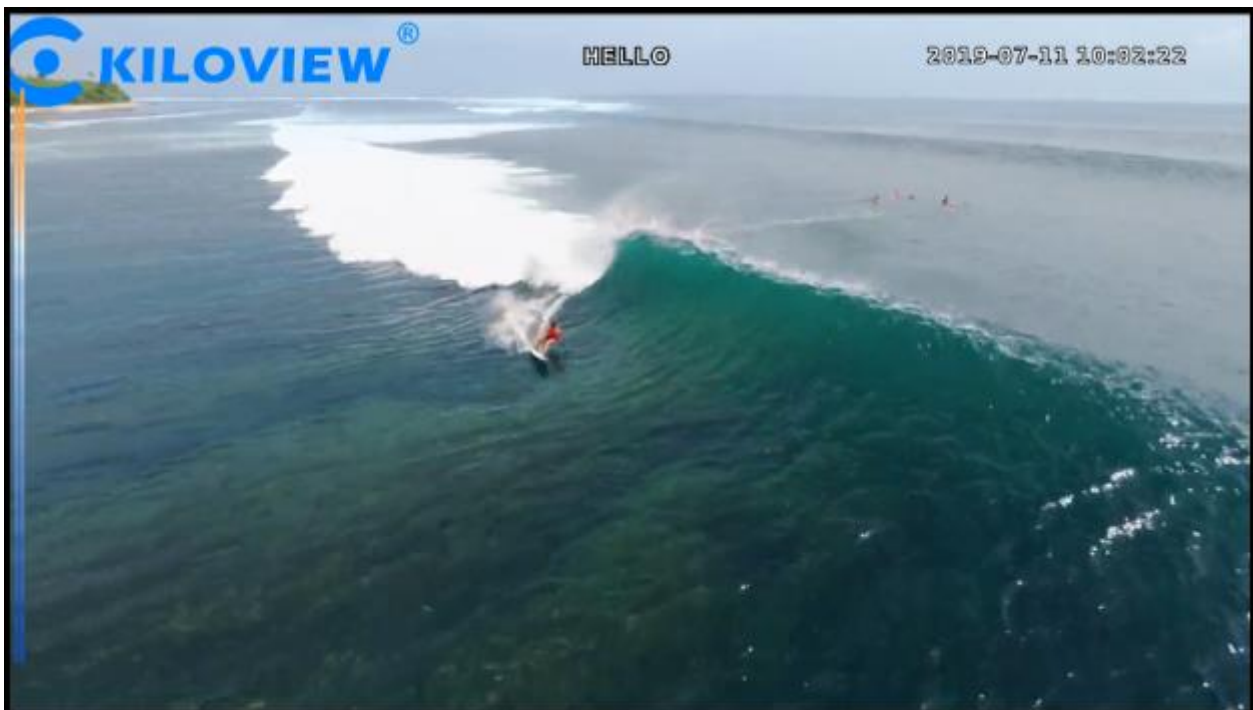

 **Note:**

- The resolution of uploaded image can not be over the video. If the resolution of the video is 1920\*1080, and the uploaded image is 3840\*2160, then the image overlay will fail to display.
- Please pay attention to the overlay position, if you add image, text and time with the same position, then some overlay may fail to display.
- If the added image occupies the majority of the video screen, the actual bitrate and the set bitrate will be greatly reduced due to the low screen dynamic fluctuation.
- For the image format, only JPEG and PNG supported.

## 6.8 Service Configuration

### 6.8.1 Web Service Configuration

The default web service port is 80 (https port is 443). You can change it (range: 1-65535) accordingly.

#### Web Service Configuration

---

**Change the web service port**

The default web service port is 80 and https port is 443, but you can change it (range: 1-65535).

NOTE: By HTTPS, if the web browser prompts privacy errors, you need add exception for correct accessing!

Web Service Port:

HTTPS Port:

 **Note:** By HTTPS, if the web browser prompts certificate errors which are caused by the browser certificate security authentication, you will need to add it to the safe list of the browser.

### 6.8.2 Onvif Service Configuration

Onvif (Open Network Video Interface Forum) is an IP-based security standard. Start the Onvif service to let a security-system which based Onvif can discovery/manage this device, and get the video streams. Onvif is a 'Web Service' based protocol, you can even write your program to control this device by Onvif web service API.

#### Onvif Service Configuration

---

**About Onvif Service**

Onvif (Open Network Video Interface Forum) is an IP-based security standard. Start the Onvif service to let a security-system which based Onvif can discovery/manage this device, and get the video streams.

You can find informations about Onvif at <http://www.onvif.org/>. Onvif is a 'Web Service' based protocol, you can even write your program to control this device by Onvif web service API.



Onvif Service Enable:

Onvif Service Port:   
(NOTE: Don't let it be same as current web service port. After version 3.99, Onvif can be accessed by default web service port, so you need not set this port specially. This setting is for compatible with old version only.)

Device Discoverable:

Location info. in Scopes:

Device name in Scopes:   
(Leave it empty to use the default device name)

Authorization:

Password of 'admin':   
(Only change password for user 'admin'. You can manage other users by Onvif tool.)



### 6.8.3 Telnet Service Configuration

Telnet service listens on port 23 for remote connection and debugging of devices. For security reasons, you can choose to close telnet services.

#### Telnet service

---

Open or close telnet service

Telnet is a remote control & debug service, it listens at TCP port 23. For security reason, you can choose to close telnet service.

Telnet service:

## 6.9 Serial Ports and PTZ

### 6.9.1 Serial Ports

With USB to RS232/RS422/RS485 adaptor (cable), after connecting to USB port, if the device and identify the serial port correctly, USB port will be listed at “Device”, then you can set the corresponding serial port parameters.

#### USB to RS232/RS485/RS422 Serial Port

Device:  [Refresh serial ports](#)

Baudrate:

Data bits:

Parity:

Stop bits:

XON/XOFF:

RTS/CTS:

 **Note:** The encoder can automatically identify the USB serial port conversion device of universal USB to Serial/FDTI chip/PL2303 chip. If the USB to RS232/RS422/RS485 converter (line) you inserted cannot be recognized and the converter chip is not supported by default, please replace the serial line.

### 6.9.2 PTZ Setting

The encoder can control the PTZ camera via Sony Visca, Pelco-D, Pelco-P protocols; you can also set the control speed.

**PTZ(Pan/Tilt/Zoom) Setting**

PTZ Protocol:

PTZ Address:

Default Pan Speed:

Default Tilt Speed:

Default Zoom Speed:

Default Focus Speed:

Default Iris Speed:

### 6.9.3 Control Panel

Through the web page of the encoder, you can control the movement, zoom and focus of the camera in all directions.

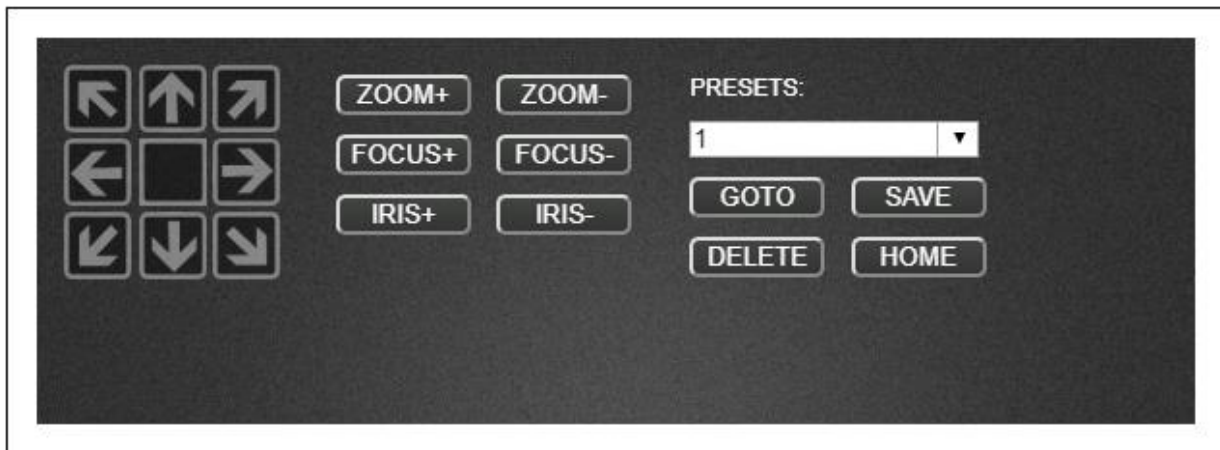

### 6.10 Quick Reset and Reboot

#### 6.10.1 Quick Reset

"Quick Reset" is used to quickly reset the video encoding service of the encoder, normally it's used to parameters come into force after modification or encoding abnormal, the current encoding service will be stopped and it will take about 3 seconds.

### 6.10.2 Reboot

“Reboot” is used to restart the device software, it will take about 3 minutes.

### 6.11 Logs and Debug

System logs are available for download, which can be provided to technical service engineers for technical analysis.

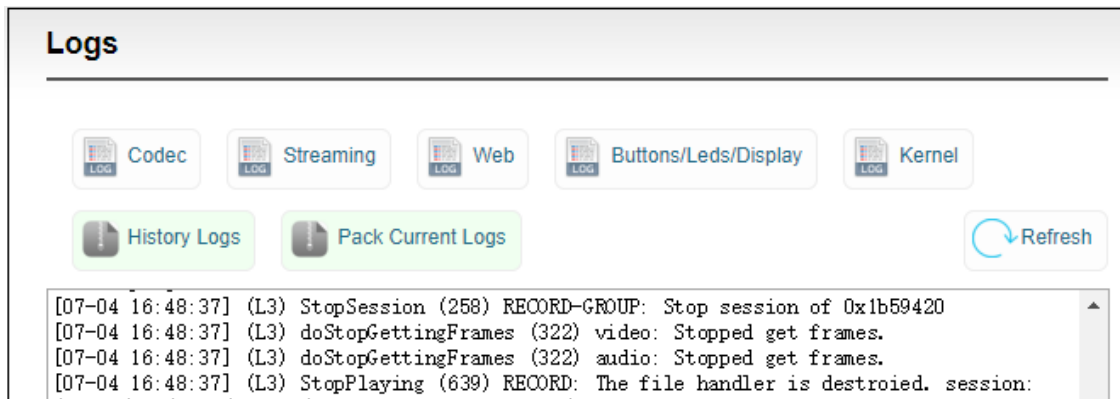

The screenshot shows a web interface titled "Logs". At the top, there are five buttons with document icons and the word "LOG" below them: "Codec", "Streaming", "Web", "Buttons/Leds/Display", and "Kernel". Below these are two green buttons: "History Logs" and "Pack Current Logs". To the right is a "Refresh" button with a circular arrow icon. At the bottom is a scrollable text area containing the following log entries:

```
[07-04 16:48:37] (L3) StopSession (258) RECORD-GROUP: Stop session of 0x1b59420
[07-04 16:48:37] (L3) doStopGettingFrames (322) video: Stopped get frames.
[07-04 16:48:37] (L3) doStopGettingFrames (322) audio: Stopped get frames.
[07-04 16:48:37] (L3) StopPlaying (639) RECORD: The file handler is destroyed. session:
```

## 6.12 Preset configuration

When there are multi-device in your system and required to set the same configurations, you could save or download the current configuration parameters to your device, then upload to other devices. After the device is restarted, the preset saved parameters will take effect.

"Preset configuration" - "Save current configuration", you can choose to save the required parameters and download, and the configuration name is customized.

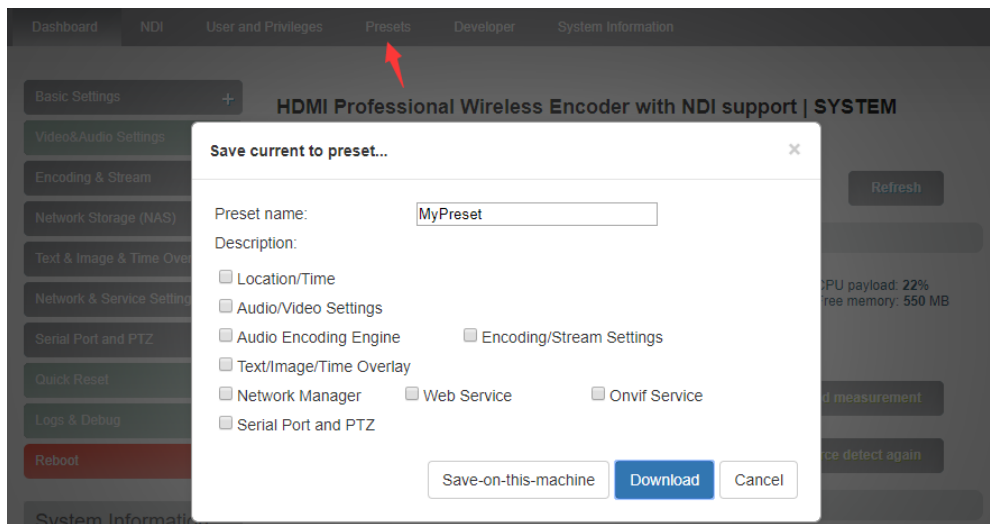

When there are other devices on site or the parameters of your device are restored to the factory, you want to use the parameters previously set. You can upload the saved configuration file in "manage or load preset configuration", restart the device after loading, and the parameter configuration will take effect.

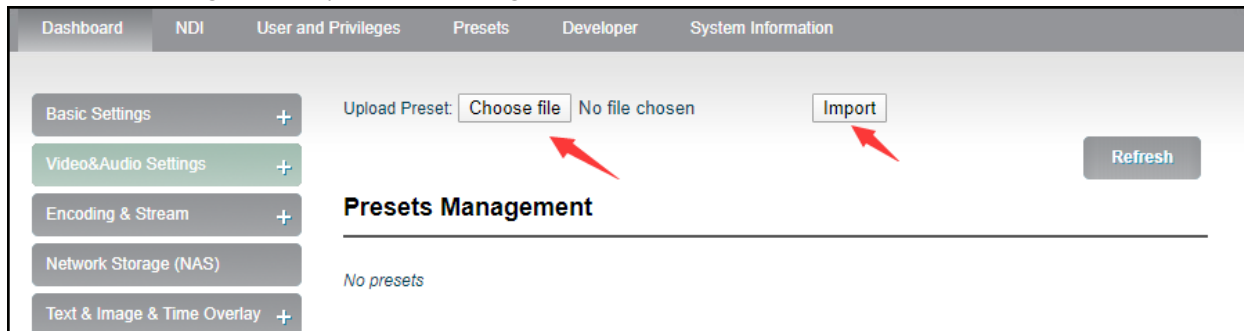

**Thank you for reading.**

**Changsha KILOVIEW Electronics CO., LTD.**

Phone: 86-731-88315979

Website: [en.kiloview.com](http://en.kiloview.com)

Support email: [support@kiloview.com](mailto:support@kiloview.com)

WhatsApp: +86-18573195156/18573195256

Skype: support\_72698/keqiu wang

Address: 188#, Middle Huanbao Rd, Yuhua District, Changsha, Hunan Province, China